

HOVER

CAMERA

V 2.0 2017.03

[\[EN\]](#) Quick Guide

[\[CHS\]](#) 快速指南

[\[CHT\]](#) 快速指南

[\[JA\]](#) クイックガイド

[\[KO\]](#) 빠른 가이드

[\[DE\]](#) Kurzanleitung

[\[ES\]](#) Guía rápida

[\[FR\]](#) Guide de démarrage rapide

[\[IT\]](#) Guida rapida

[\[NL\]](#) Korte handleiding

[\[PT\]](#) Guia rápido

[\[RU\]](#) Краткое руководство

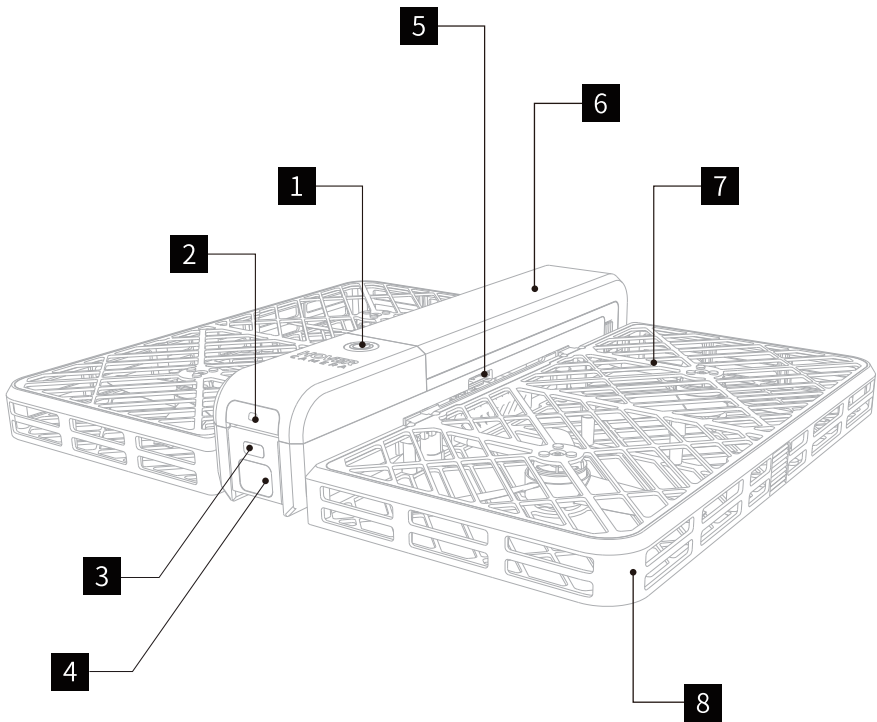

• 1

Power Button 电源键 電源鍵
 電源ボタン 전원 버튼 Ein-/Ausstaste
 Botón de encendido Bouton de marche/arrêt
 Pulsante di alimentazione Aan/uit-knop
 Botão Ligar/Desligar Кнопки питания

• 2

LED Indicator Light LED指示灯 LED指示燈
 LED 인진저터라 램프 LED 표시등
 LED-Anzeige Indicador luminoso LED Voyant LED
 Spia indicatore LED Ledlampje
 Luz de indicação LED Светодиодный индикатор

• 3

Flash 闪光灯 閃光燈
 فلاش فليش
 Blitz Flash
 Разъем Flash

• 4

Camera 摄像头 攝像頭 カメラ
 카메라 Kamera Cámara Cámara
 Fotocamera Camera Câmara Камера

• 5

USB Port USB 插口 USB 插口 USB 포트
 USB 포트 USB-Port Puerto USB Port USB
 Porta USB USB-poort Porta USB Порт USB

• 6

Battery 电池 電池 電池 배터리
 Akku Bateria Batterie Batteria
 Accu Bateria Аккумулятор

• 7

Top Plate 上碳板 上碳板 上部プレート 상부 판
 Obere Abdeckung Placa superior Plaque supérieure
 Lastra superiore Bovenplaat Placa superior Верхняя панель

• 8

Side Frame 边框 邊框 側面フレーム
 측면 프레임 Seitenrahmen Marco Structure latérale
 Telaio Zijframe Estructura lateral Боковая рама

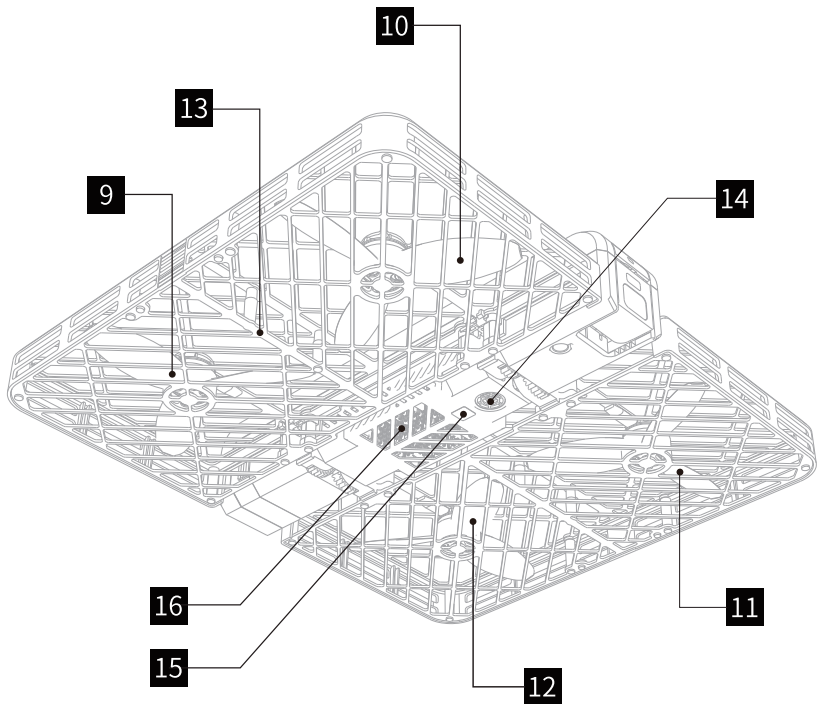

• 9 11

Propeller (CW*) 螺旋桨 (CW*) 螺旋桨 (CW*) 프로베라 (CW*)
 프로펠러 (CW*) Propeller (UZS*) Hélice (CW*) Hélice (CW*)
 Elica (CW*) Пропеллер (CW*) Hélice (RH*) Propeller (CW*)

* _____
 CW: Clockwise CW: 顺时针方向 CW: 順時針方向 CW: 時計回り
 CW: _____ UZS: Im Uhrzeigersinn CW: Sentido horario
 CW :sens horaire CW: senso orario CW: по часовой стрелке
 RH: Rotação horária CW: Rechtsom

• 13

Bottom Plate 下碳板 下部プレート 하부 판
 Untere Abdeckung Placa inferior Plaque inférieure
 Lastra inferiore Bodemplaat Placa do fundo
 Нижняя панель

• 16

Heat Vent 散热口 排氣孔 排熱用の通気孔 열 환공구
 Salida de aire caliente Wärmeabzug Ventilation thermique
 Ventola di raffreddamento Ventilator voor warmteafvoer Ventilação

• 10 12

Propeller (CCW*) 螺旋桨 (CCW*) 螺旋桨 (CCW*) 프로베라 (CCW*)
 프로펠러 (CCW*) Propeller (GUZS*) Hélice (CCW*) Hélice (CCW*)
 Elica (CCW*) Пропеллер (CCW*) Hélice (RAH*) Propeller (CCW*)

* _____
 CCW: Counter-Clockwise CCW: 逆时针方向 CCW: 逆時針方向
 CCW: 反時計回り CCW: _____ GUZS: Gegen den Uhrzeigersinn
 CCW: Sentido antihorario CCW :sens anti-horaire CCW: senso antiorario
 CCW: против часовой стрелки RAH: Rotação anti-horária CCW: Linksom

• 14

Sonar 声呐 聲納
 โซナー 소나 Sonar
 Sónar Sonar Sonar
 Sonar Sonar Сонар

• 15

Optical Flow Sensor 光流传感器 光流傳感器
 옵티컬플로우센서 광학 흐름 센서
 Sensor de flujo óptico Optischer Strömungssensor
 Capteur de flux optique Sensore di flusso ottico
 Optische stromingssensor Sensor de fluxo ótico
 Оптический потоковый датчик

Step 1: Download the Hover Camera App

Scan the QR code below to download and install the Hover Camera App.



Download the User Manual from the official website for more information.

*This guide is subject to change without prior notice. Please visit the official website for more detailed information.

Step 2: Charge the Battery

To charge batteries, plug them into the battery charger:

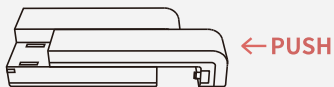

Note:

The charger can charge up to 2 batteries at a time.



Solid Yellow: Charging

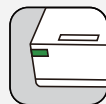

Solid Green: Fully Charged

Note:

A fully charged battery offers a better flying experience.

Step 3: Plug in / Remove the Battery

Press and hold the grips on each side of the battery, and pull the battery out firmly as demonstrated.

← PUSH TO PLUG IN

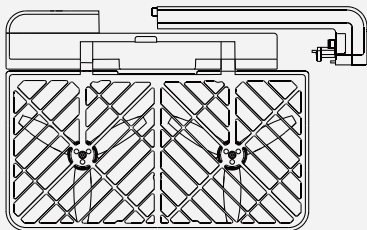

PULL →

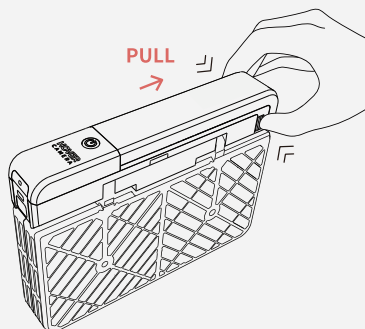

Step 4: Turn on and Connect

Press the power button for 2 seconds until the green LED indicator light blinks twice. Wait for approximately 15 seconds for Hover Camera Passport to initialize. Once it's finished booting up, you will hear a sound. At the same time Hover Camera Passport's power light will stop flashing and turn into a solid color.

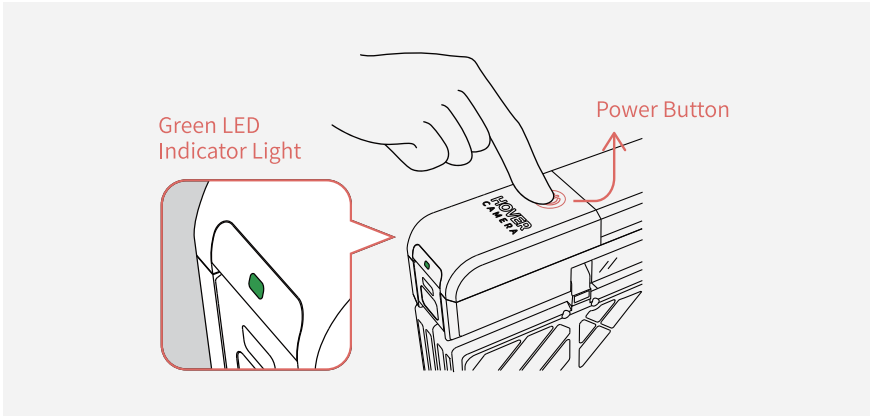

Enter the Wi-Fi Settings screen on your device and connect the device to the “Hover Camera” hotspot.

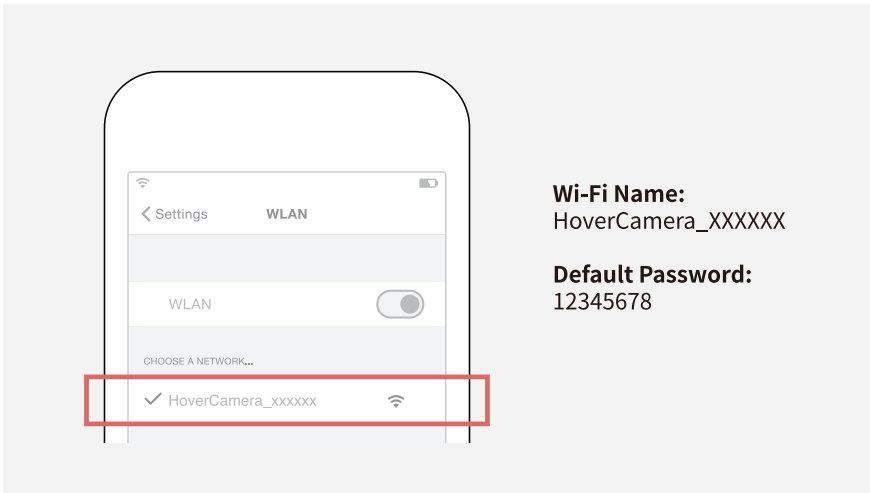

Wi-Fi Name:
HoverCamera_XXXXXX

Default Password:
12345678

We recommend you to change your Wi-Fi name and default password.

Step 5: Release and Hover

Unfold Hover Camera Passport and hold it level to the ground. Press the power button to start the propellers.

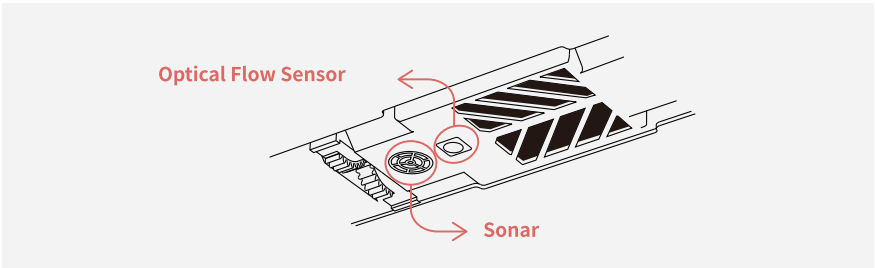
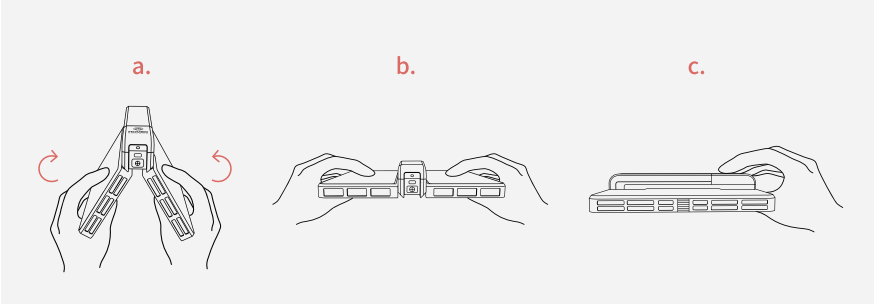

Caution: Do not cover the optical flow sensor or sonar before releasing it.

When the propellers speed up, let go!

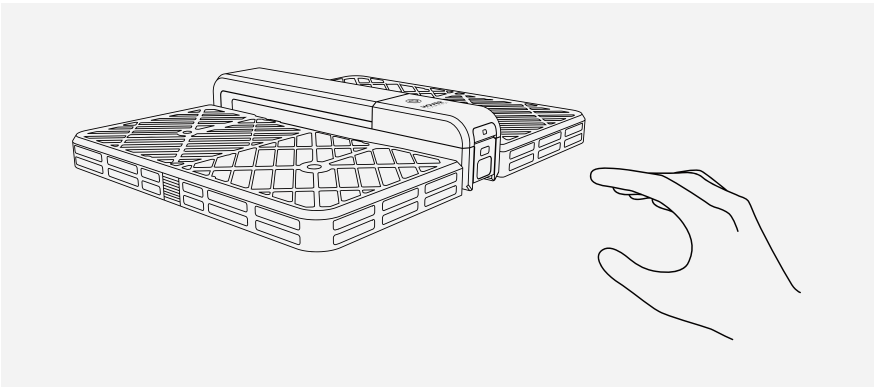

Step 6: Control Your Hover Camera Passport

Open the Hover Camera App and enjoy flying Hover Camera Passport.

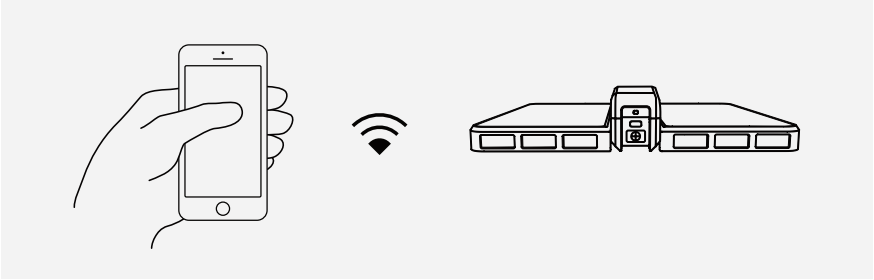

Step 7: Retrieve/Land Hover Camera Passport

Grab Hover Camera Passport as demonstrated, and then press the power button to stop the propellers.

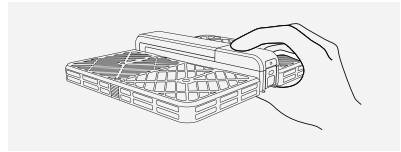

Or tap the “Landing” icon



in the app to land Hover Camera Passport.

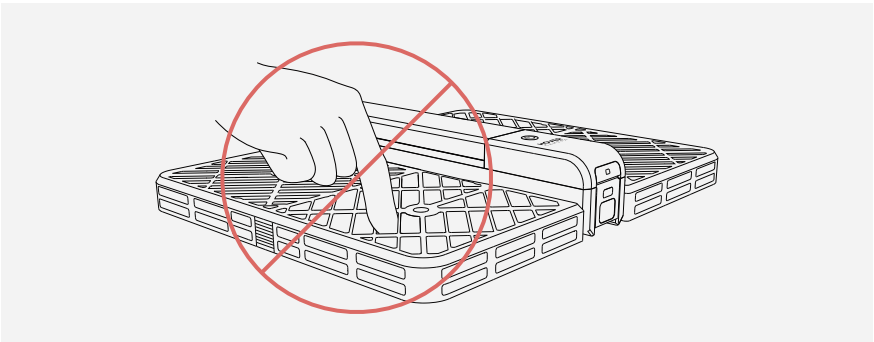

Caution:

Do not insert finger or object into the frame.

Please check the Disclaimer and Safety Instructions for more details at GetHover.com/support.

第一步：下载Hover Camera App

扫描二维码下载并安装Hover Camera App。



了解更多信息，请前往官网下载《用户手册》。
* 本指南如有更新，恕不另行通知。请登录官网获取最新信息。

第二步：充电

将电池插入充电器。

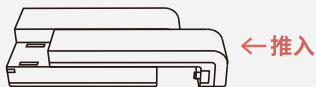

提示：
充电器可同时为两块电池充电。



黄灯常亮：充电中



绿灯常亮：电已充满

提示：
建议将电池充满电后使用，飞行体验更佳。

第三步：安装/拆卸电池

捏住电池两侧卡扣的同时，沿图示方向拔出电池。

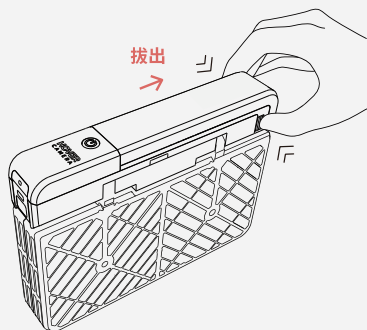
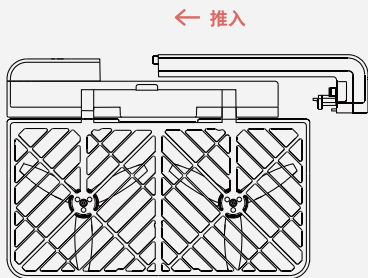

第四步：放飞前准备

长按电源键约2秒至绿色LED灯闪烁两下。等待约15秒，电源灯由闪烁变为常亮，电调声响起，开机成功。

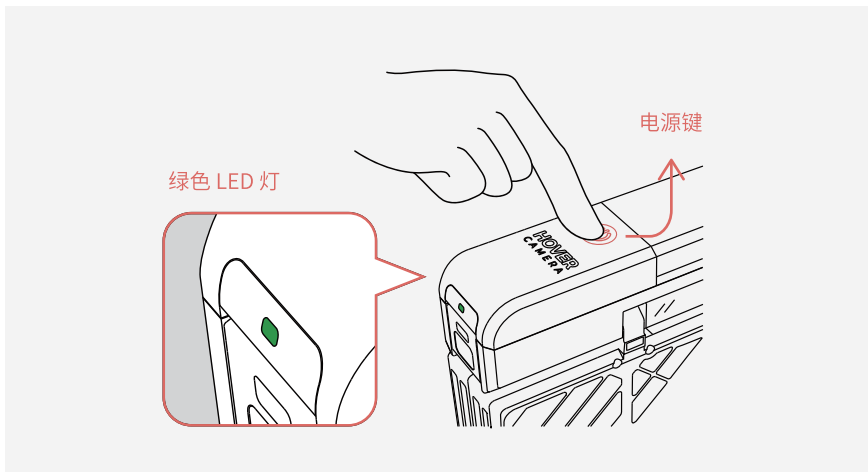

进入移动设备的Wi-Fi设置页面，连接Hover Camera 小黑侠跟拍无人机热点。



建议及时修改Hover Camera 小黑侠跟拍无人机 Wi-Fi名和密码。

第五步：放飞Hover Camera 小黑侠跟拍无人机

CHS

如下图所示展开Hover Camera 小黑侠跟拍无人机并端平，短按电源键。

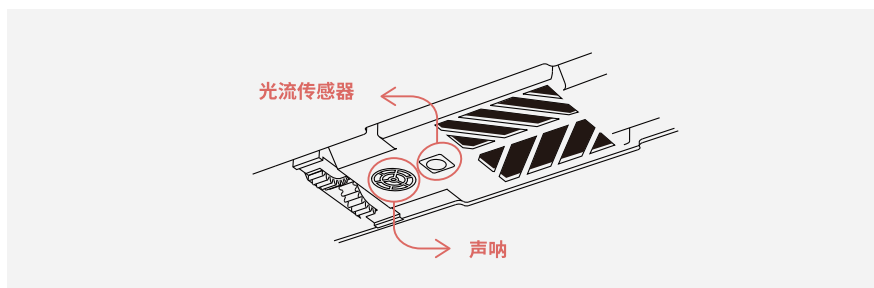
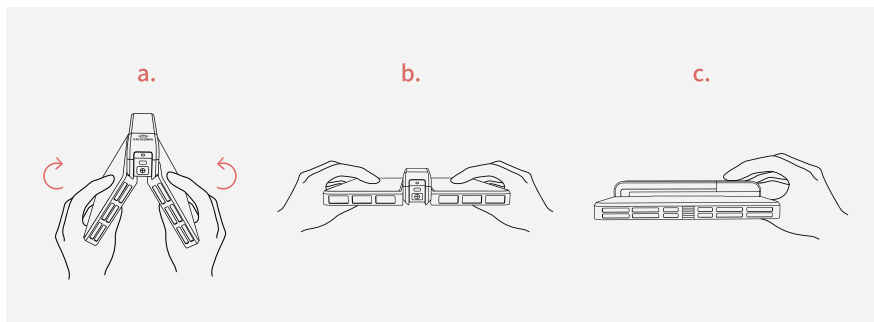

注意：放飞时，手指不要遮挡住光流传感器和声呐。

当螺旋桨快速旋转时即可松手放飞。

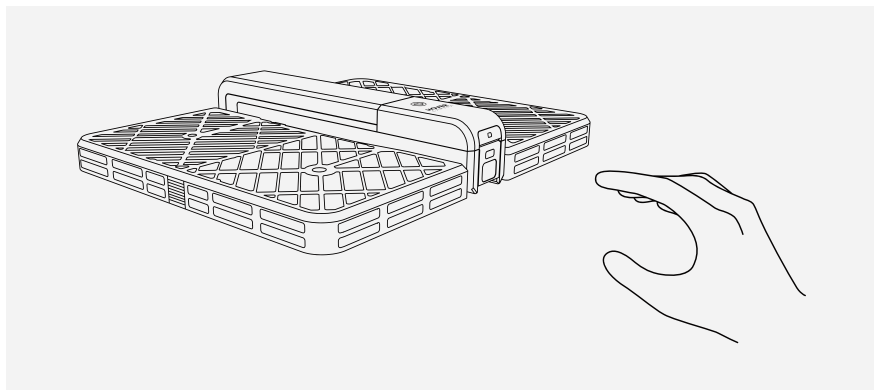

第六步:使用Hover Camera 小黑侠跟拍无人机

打开Hover Camera App,享受飞行操控带来的极致体验。

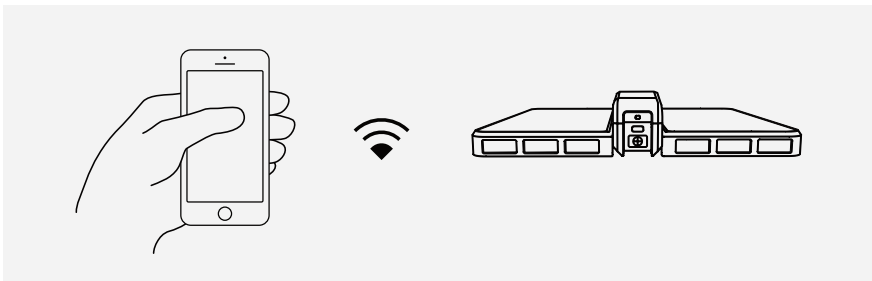

第七步: 收回/降落Hover Camera 小黑侠跟拍无人机

如图摘取飞行中的Hover Camera 小黑侠跟拍无人机并短按电源键,螺旋桨将停止旋转。

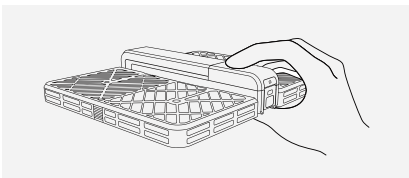

或在Hover Camera App内点击“一键降落”图标 来收回机器。

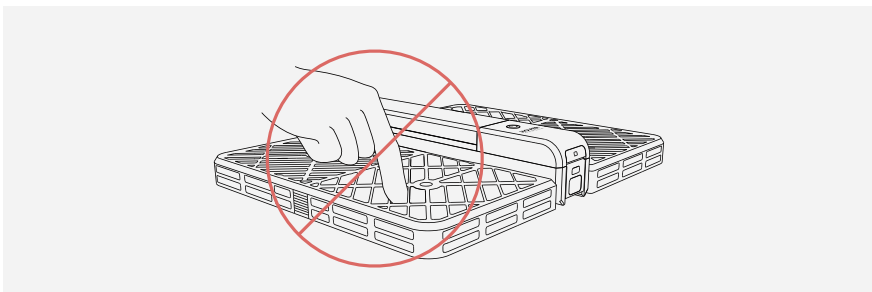

注意:

请勿将手指或其他物品伸入碳板内。更多安全事项请参考
GetHover.com/support上的免责声明和安全操作手册。

第一步：下載 Hover Camera 應用程式

掃描下方二維碼，下載並安裝 Hover Camera 應用程式。



如需更多資訊，請前往官網下載《使用手冊》
*本指南如有更新，恕不另行通知。請瀏覽官網取得最新資訊。

CHT

第二步：充電

將電池插入充電器。

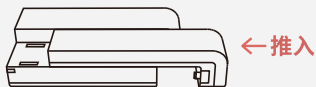

提示：
充電器可同時為兩顆電池充電。



黃燈恆亮：充電中

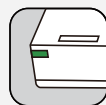

綠燈恆亮：電已充飽

提示：
建議將電池充滿電後再使用，飛行體驗更佳。

第三步：安裝 / 拆卸電池

捏住電池兩側卡扣的同時，沿圖示方向拔出電池。

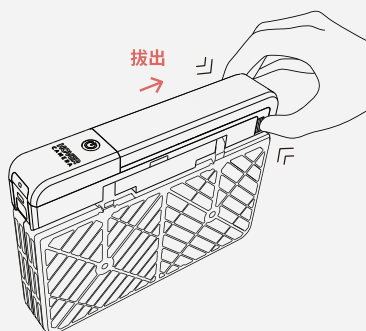
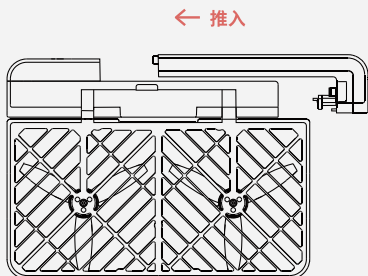

第四步：放飛前準備

長按電源鍵約 2 秒，直到綠色 LED 燈閃爍兩下。等待約 15 秒，電源燈由閃爍變為恆亮，電調聲響起，表示開機成功。

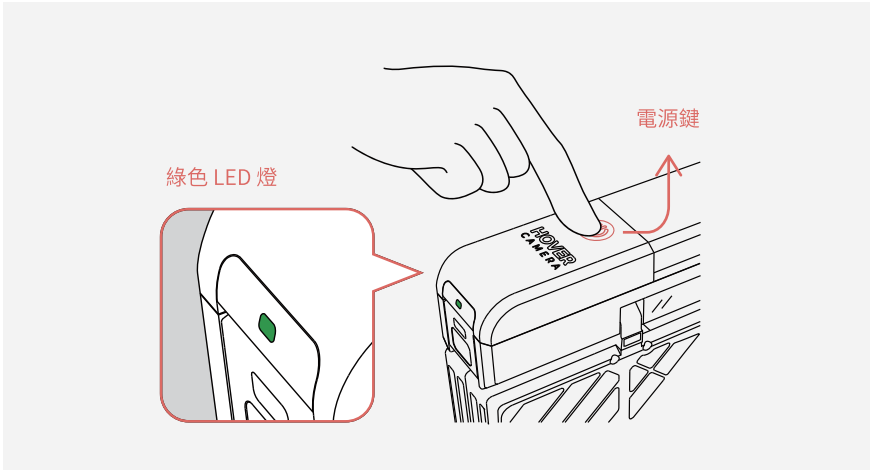

進入行動裝置的 Wi-Fi 設定頁面，連接 Hover Camera Passport 無線基地台。



建議盡早修改 Hover Camera Passport Wi-Fi 名稱和密碼。

第五步：放飛 Hover Camera Passport

如下圖所示展開 Hover Camera Passport 並將其水平拿好，短按電源鍵。

CHT

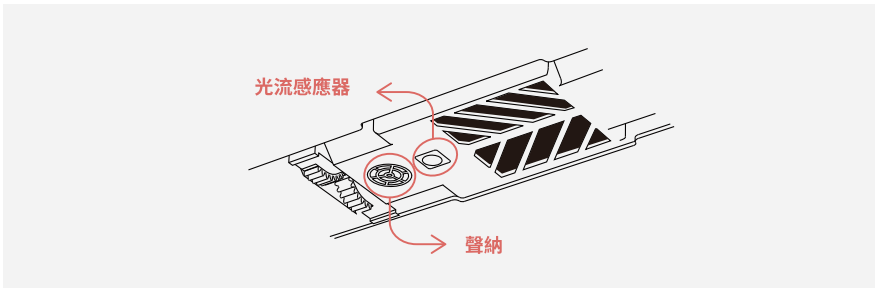
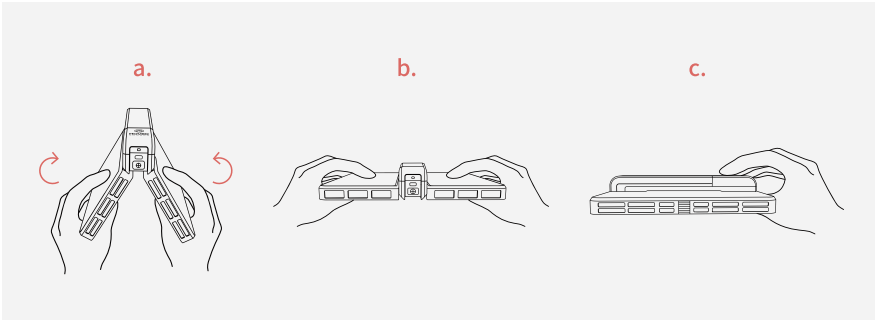

注意：放飛時，手指不要擋住光流感應器和聲納。

螺旋槳快速旋轉時即可鬆手放飛。

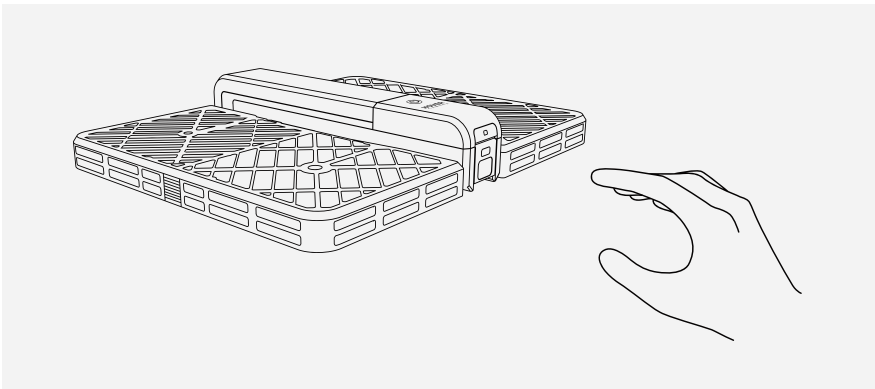

第六步:使用 Hover Camera Passport

打開 Hover Camera 應用程式, 享受飛行操控帶來的極致體驗。

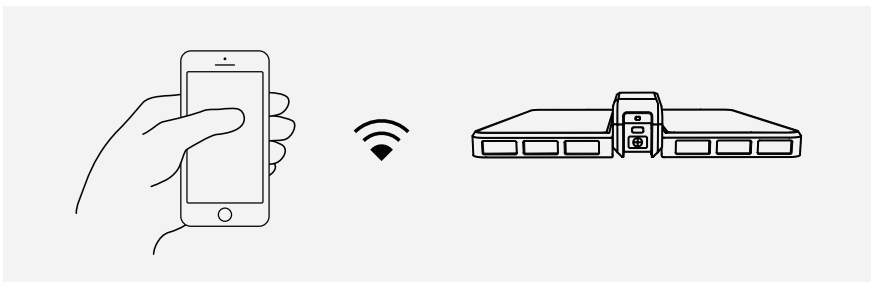

第七步:收回 / 降落 Hover Camera Passport

如圖摘取飛行中的 Hover Camera Passport, 並短按電源鍵, 螺旋槳將停止旋轉。

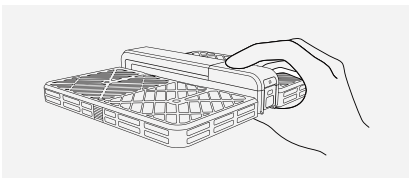

或在Hover Camera 應用程式內按一下「一鍵降落」圖示來回收機器。

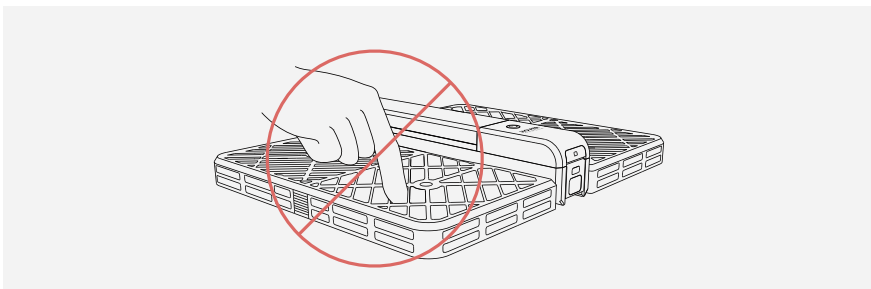

注意:

請勿將手指或其他物品伸入碳板內。欲瞭解更多安全事項, 請參閱 GetHover.com/support 上的免責聲明和安全操作手冊。

ステップ 1: Hover Camera アプリのダウンロード

以下の QR コードをスキャンして、Hover Camera アプリをダウンロードし、インストールします。



詳細については、公式ウェブサイトから『ユーザーマニュアル』をダウンロードしてください。

*本ガイドは事前に通知することなく変更される場合があります。詳細については、公式ウェブサイトをご覧ください。

JA

ステップ 2: 電池の充電

電池を充電するには、電池の充電器に差し込みます。

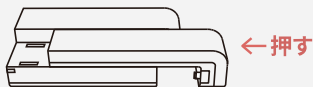

注:
充電器では、最大2個の電池を同時に充電できます。



黄色に点灯: 充電中

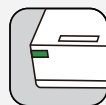

緑色に点灯: 完全に充電済み

注: 安定した飛行のため、完全に充電済みの電池を使用することが推奨されます。

ステップ 3: 電池の挿入/取り外し

図に示すように、電池の両側の取っ手を掴み、強く引っ張ります。

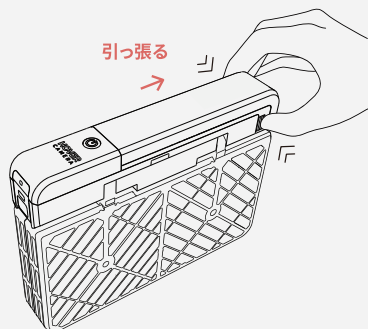
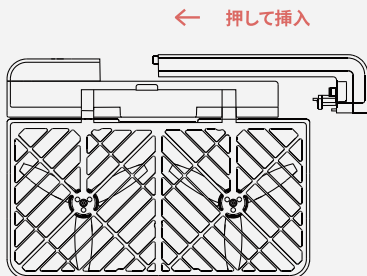

ステップ 4: 電源オンと接続

電源ボタンを2秒間押し、緑色のLEDインジケータランプが2回点滅するのを確認します。Hover Camera Passport が初期化されるまで、約 15 秒待ちます。起動が完了すると、音が出ます。同時に Hover Camera Passport の電源ランプが点滅を止め、点灯します。

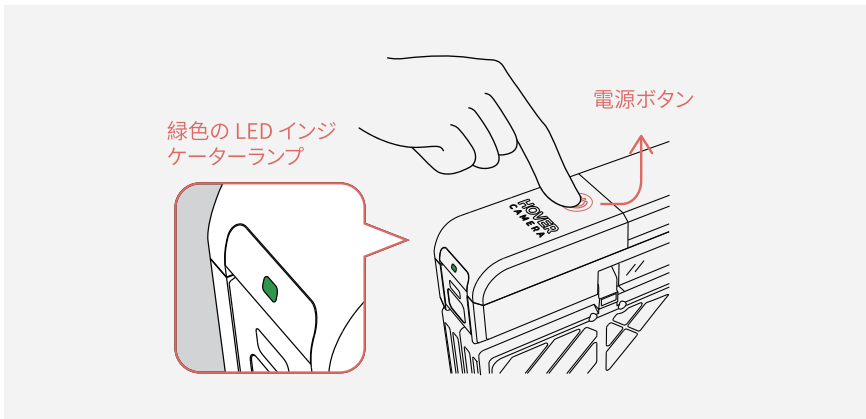

JA

デバイスの [Wi-Fi Settings] (Wi-Fi 設定) 画面を表示し、デバイスを「Hover Camera」ホットスポットに接続します。

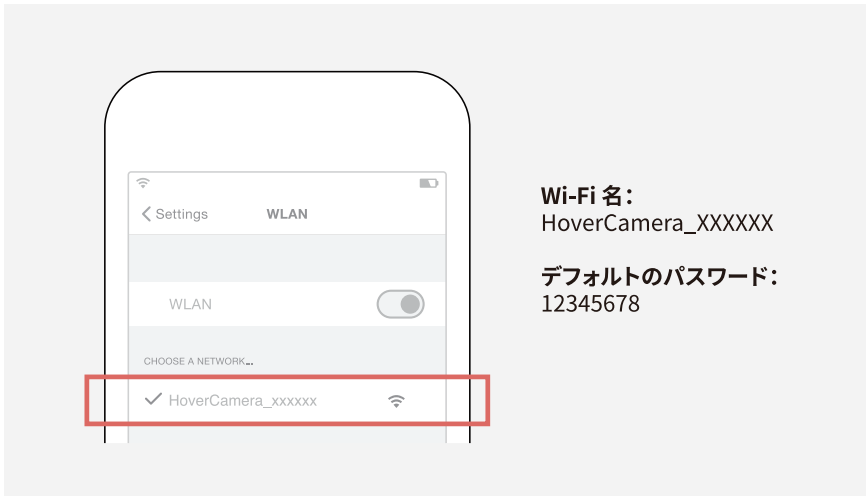

Wi-Fi 名とデフォルトのパスワードは変更することをおすすめします。

ステップ 5: 離陸と空中停止

Hover Camera Passport を開いて、地面に水平に持ちます。電源ボタンを押して、プロペラを開始します。

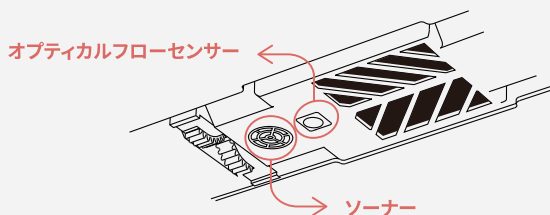
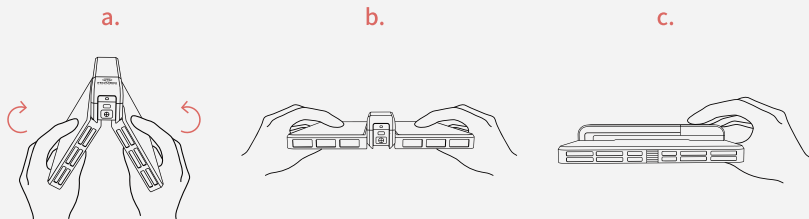

注意: 手を離す前に、オプティカルフローセンサーまたはソナーを覆わないようにしてください。

プロペラの回転が速くなったら、飛行準備完了です。

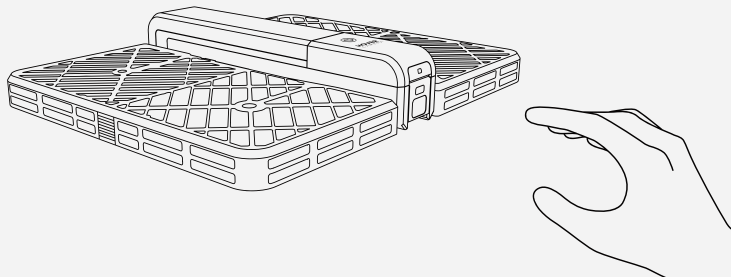

ステップ 6: Hover Camera Passport の操縦

Hover Camera アプリを開き、Hover Camera Passport を操縦します。

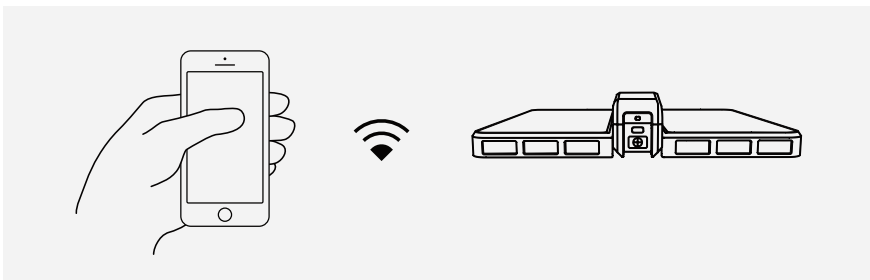

JA

ステップ 7: Hover Camera Passport の回収/着地

図に示すように Hover Camera Passport を掴み、電源ボタンを押してプロペラを停止します。

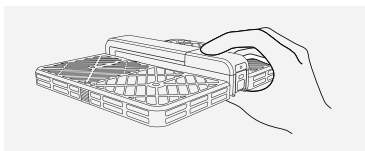

または、アプリの [Landing] (着地) アイコン  をタップして、Hover Camera Passport を着地させます。

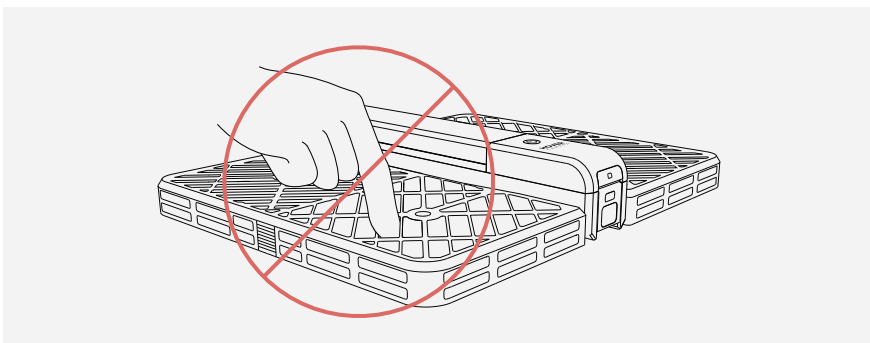

注意:

フレームに指や異物を挿入しないでください。

詳細については、『免責事項および安全上の注意事項』(GetHover.com/support から参照) をご覧ください。

1단계: Hover Camera 앱 다운로드

아래의 QR 코드를 스캔하여 Hover Camera 앱을 다운로드 및 설치합니다.



자세한 정보를 알아보려면 공식 웹사이트에서 사용 설명서를 다운로드하십시오.
*본 안내는 사전 고지 없이 바뀔 수 있습니다. 자세한 정보를 알아보려면 공식 웹사이트를 방문해 주십시오.

2단계: 배터리 충전

배터리를 충전하려면 배터리 충전기에 꽂아 주십시오.

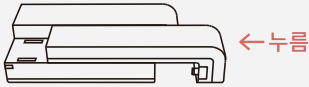

참고:
한번에 최대 2개의 배터리를 충전할 수 있습니다.

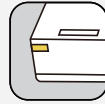

노란색: 충전 중

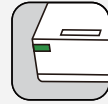

녹색: 완전히 충전됨

참고:
배터리를 완전히 충전하면 비행 경향이 향상됩니다.

3단계: 배터리 연결/제거

배터리 양 측면에 있는 손잡이를 누른 채로 그림과 같이 배터리를 세계 당겨 빼냅니다.

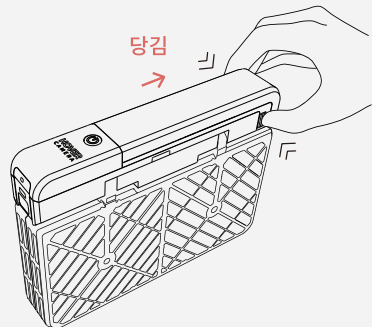
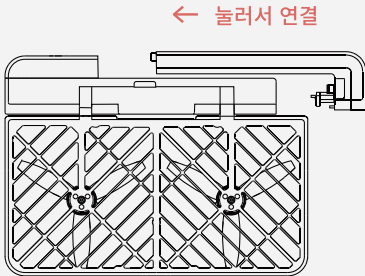

4단계: 켜서 연결하기

녹색 LED 표시등이 두 번 깜박일 때까지 전원 버튼을 2초 동안 누릅니다. Hover Camera Passport가 시작될 때까지 약 15초 동안 기다립니다. 일단 부팅이 완료되면 음향이 들립니다. 동시에 Hover Camera Passport의 전원 등이 깜박임을 멈추고 녹색으로 바뀝니다.

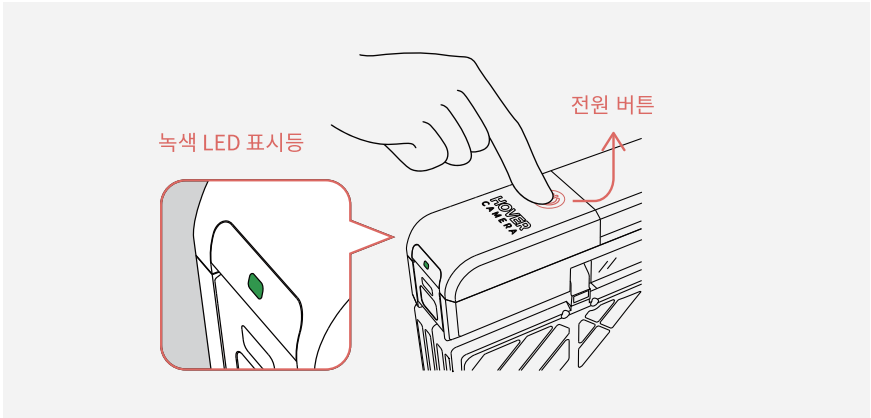

기기에서 Wi-Fi 설정 화면으로 들어가 기기를 “Hover Camera” 핫스팟에 연결합니다.

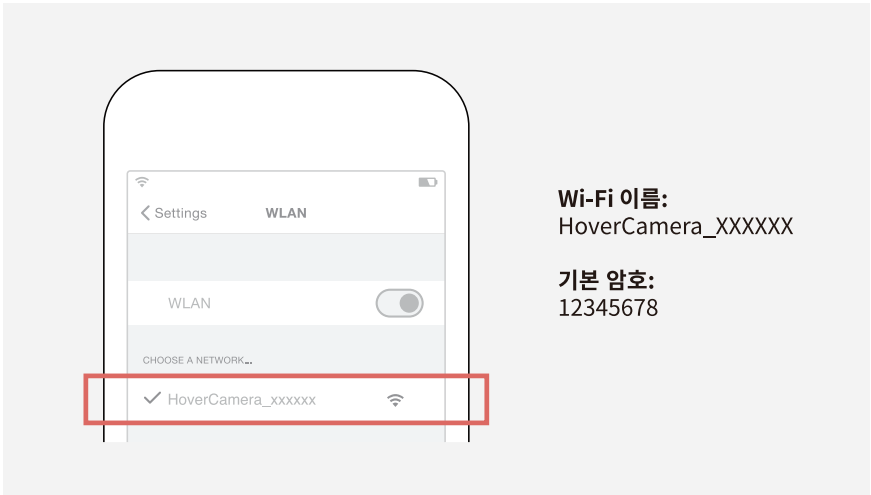

Wi-Fi 이름과 기본 암호를 변경하는 것을 권장합니다.

5단계: 해제 및 호버

Hover Camera Passport를 펴고 지면에 대해 수평을 유지합니다. 전원 버튼을 눌러 프로펠러를 작동합니다.

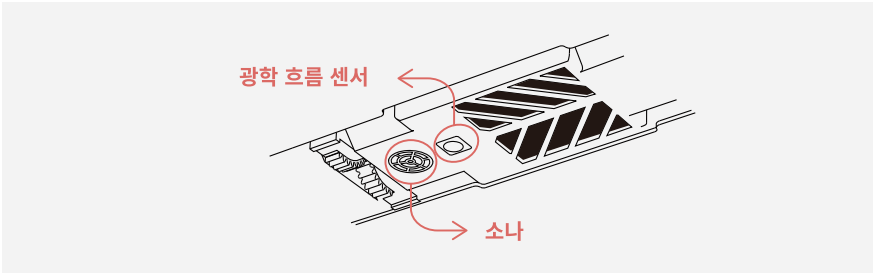
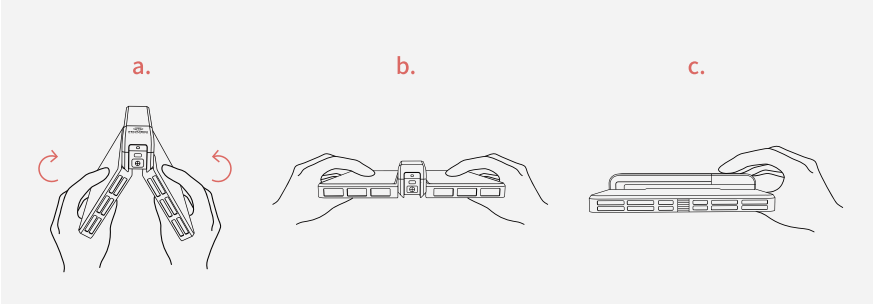

주의: 광학 흐름 센서 또는 소나를 해제하기 전에는 덮어 두지 마십시오.

프로펠러가 가속되면 시작됩니다.

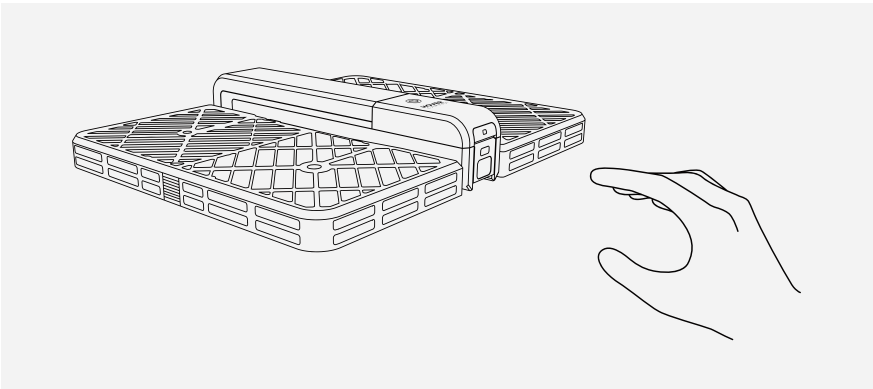

6단계: Hover Camera Passport 제어

Hover Camera 앱을 열고 Hover Camera Passport를 비행합니다.

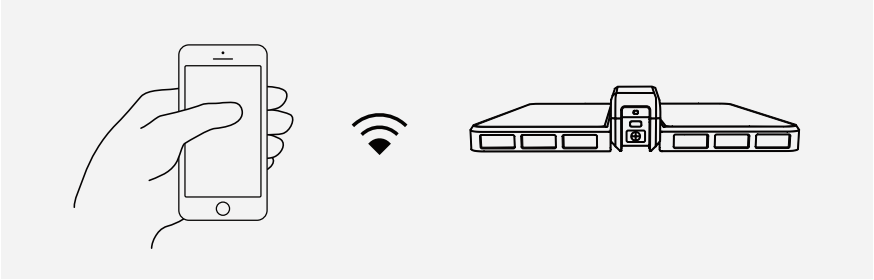

KO

7단계: Hover Camera Passport 회수/착륙

그림과 같이 Hover Camera Passport를 잡은 후 전원 버튼을 눌러 프로펠러를 멈춥니다.

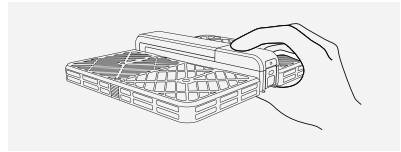

또는 앱에서 “착륙” 아이콘을



눌러 Hover Camera Passport를 착륙시킵니다.

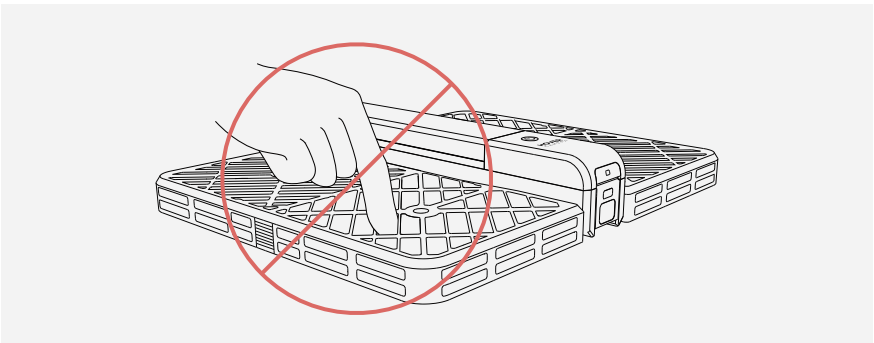

주의:

손가락이나 물체를 프레임에 끼우지 마십시오.

책임의 부인 및 안전 지침에 대한 자세한 내용은 GetHover.com/support에서 확인해 주십시오.

Schritt 1 Hover Camera-App herunterladen

Scannen Sie den unten angegebenen QR-Code, um die Hover Camera-App herunterzuladen und zu installieren.

Laden Sie das Benutzerhandbuch von der offiziellen Website herunter, um weitere Informationen zu erhalten.

*Diese Anleitung kann ohne vorherige Benachrichtigung geändert werden. Besuchen Sie die offizielle Website, um detailliertere Informationen zu erhalten.



Schritt 2 Den Akku laden

Um die Akkus zu laden, verbinden Sie sie mit dem Akkuladegerät:

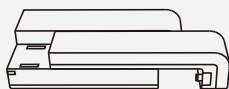

← DRÜCKEN

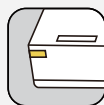

Konstant gelb: Wird geladen



Konstant grün: Voll geladen

Hinweis: Mit dem Ladegerät können bis zu 2 Akkus gleichzeitig geladen werden.

Hinweis: Ein vollständig geladener Akku bietet Ihnen ein besseres Flugerlebnis.

Schritt 3 Akku anschließen/entfernen

Halten Sie die Bereiche an den Seiten des Akkus gedrückt und ziehen Sie den Akku vorsichtig heraus, wie unten dargestellt.

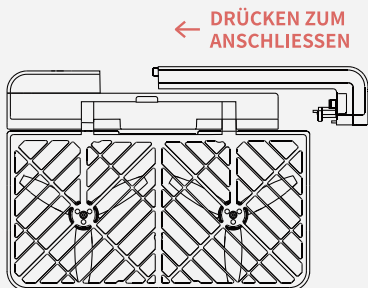

← DRÜCKEN ZUM ANSCHLIESSEN

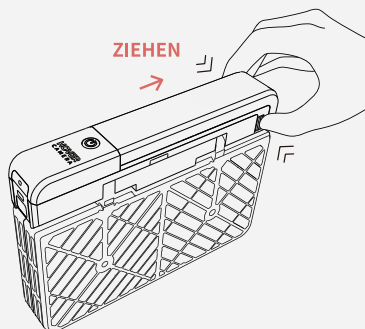

→ ZIEHEN

Schritt 4 Einschalten und verbinden

Drücken Sie 2 Sekunden lang die Ein-/Austaste, bis die grüne LED-Anzeige zweimal blinkt. Warten Sie ca. 15 Sekunden, bis die Hover Camera Passport gestartet ist. Sobald dieser Vorgang abgeschlossen ist, wird ein Ton ausgegeben. Gleichzeitig blinkt die Netzlampe der Hover Camera Passport nicht mehr und zeigt eine einheitliche Farbe an.

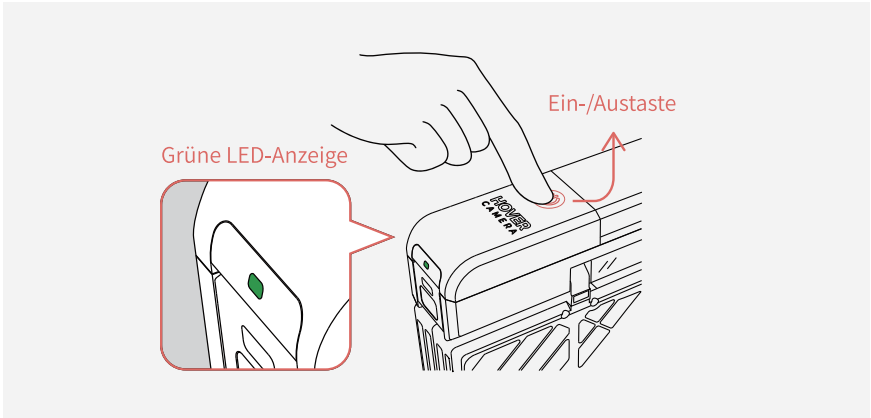

DE

Rufen Sie den Bildschirm „Wi-Fi Settings“ (WLAN-Einstellungen) auf Ihrem Gerät auf und verbinden Sie es mit dem Hotspot „Hover Camera“.

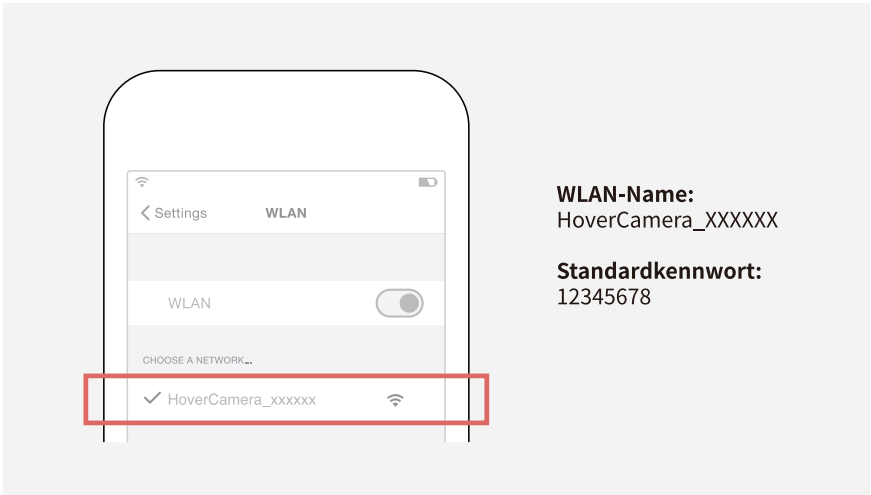

WLAN-Name:
HoverCamera_XXXXXX

Standardkennwort:
12345678

Wir empfehlen, dass Sie Ihren WLAN-Namen und das Standardkennwort ändern.

Schritt 5 Freigeben und schweben

Falten Sie die Hover Camera Passport auseinander und halten Sie sie über den Boden. Drücken Sie auf die Ein-/Austaste, um die Propeller zu starten.

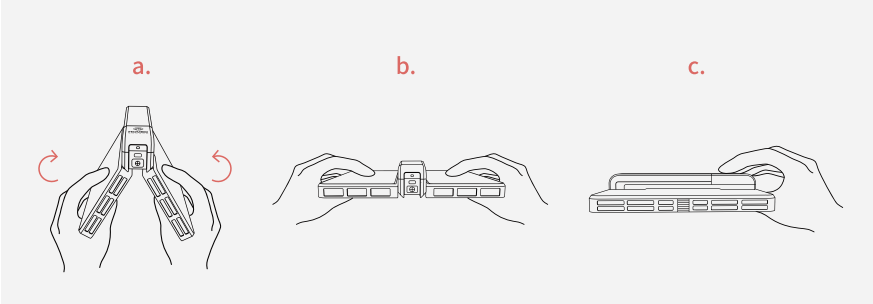

DE

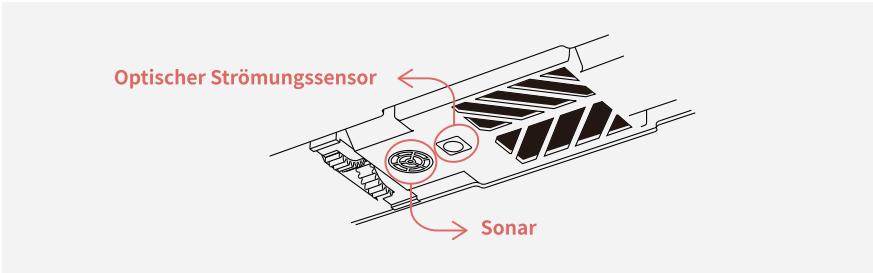

Vorsicht: Decken Sie den optischen Strömungssensor oder das Sonar nicht ab, bevor Sie das Gerät loslassen.

Wenn sich der Propeller in Bewegung setzt, kann es losgehen!

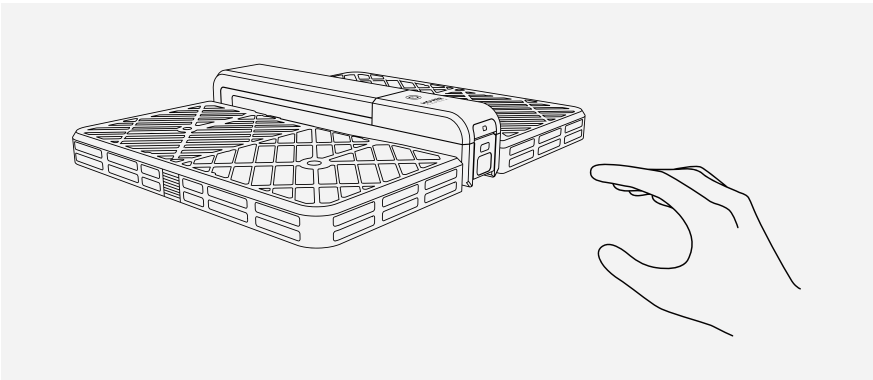

Schritt 6 Ihre Hover Camera Passport steuern

Öffnen Sie die Hover Camera-App und genießen Sie den Flug der Hover Camera Passport.

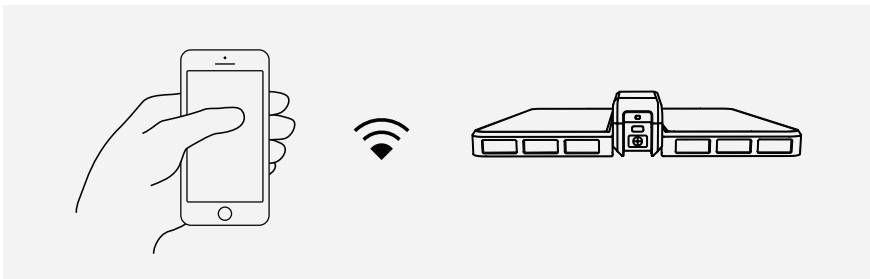

Schritt 7 Hover Camera Passport bergen/landen

Greifen Sie die Hover Camera Passport wie unten dargestellt und drücken Sie die Ein-/Austaste, um die Propeller anzuhalten.

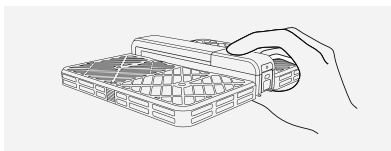

DE



Oder tippen Sie auf Schaltfläche

„Landing“ (Landen) in der App, um die Hover Camera Passport zu landen.

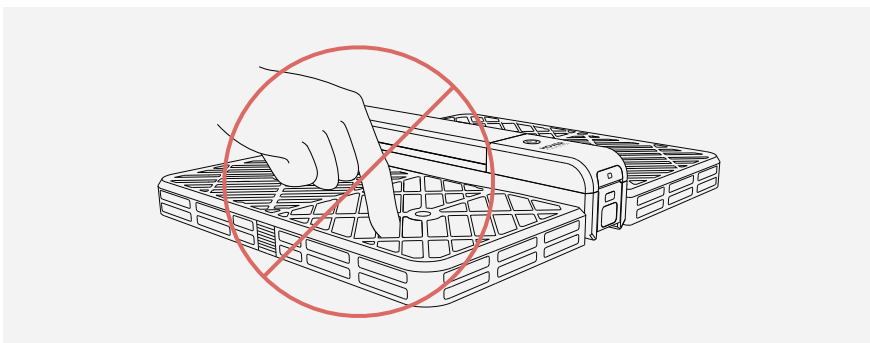

Vorsicht:

Führen Sie keine Finger oder andere Objekte in den Rahmen ein.
Lesen Sie für weitere Informationen den Haftungsausschluss und die Sicherheitshinweise auf GetHover.com/support.

Paso 1: Descargue la aplicación Hover Camera

Escanee el código QR que aparece a continuación e instale la aplicación Hover Camera.



Para obtener más información, descargue el Manual de usuario desde la página web oficial.

*Esta guía está sujeta a cambios sin previo aviso. Para obtener información más detallada, visite la página web oficial.

Paso 2: Cargue las baterías

Para cargar las baterías, conéctelas al cargador.

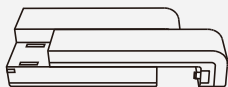

← DESGLIZAR



Amarillo fijo: cargando



Verde fijo: carga completa

Nota: El cargador puede cargar un máximo de 2 baterías de forma simultánea.

Nota: Una batería completamente cargada ofrece una mejor experiencia de vuelo.

ES

Paso 3: Conecte o extraiga las baterías

Mantenga presionadas las marcas laterales de la batería y tire de la batería con firmeza, tal y como se muestra.

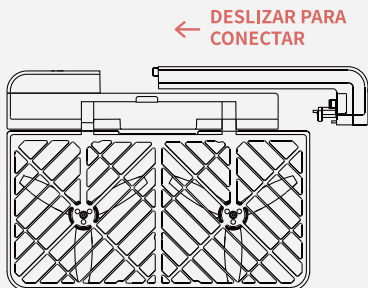

← DESGLIZAR PARA CONECTAR

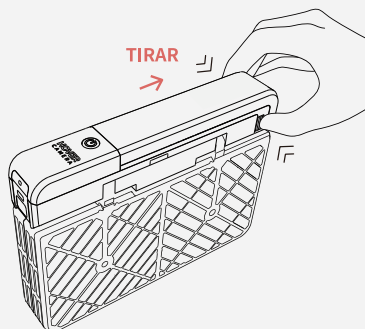

→ TIRAR

Paso 4: Encienda y conecte el Hover Camera Passport

Pulse el botón de encendido durante 2 segundos hasta que el indicador luminoso LED verde parpadee dos veces. Espere unos 15 segundos para que el Hover Camera Passport se inicie. Una vez que se haya iniciado, emitirá un sonido. Al mismo tiempo, el indicador de encendido del Hover Camera Passport dejará de parpadear y se iluminará en un color fijo.

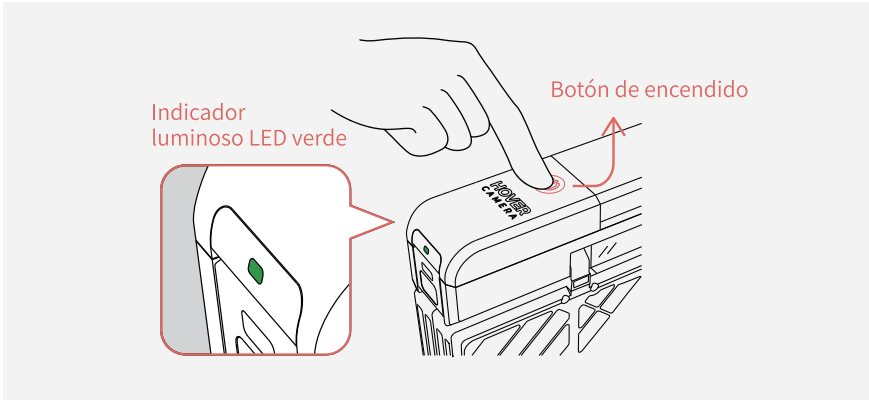

ES

Vaya a la pantalla Ajustes de Wi-Fi de su dispositivo y conecte el dispositivo con la zona activa "Hover Camera".

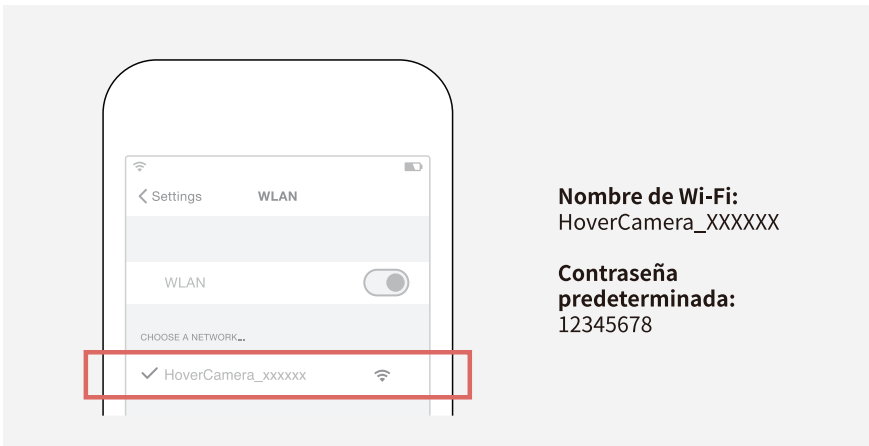

Le recomendamos que cambie el nombre de Wi-Fi y la contraseña predeterminada.

Paso 5: Inicie el vuelo

Abra el Hover Camera Passport y sujételo paralelo al suelo. Pulse el botón de encendido para que las hélices empiecen a girar.

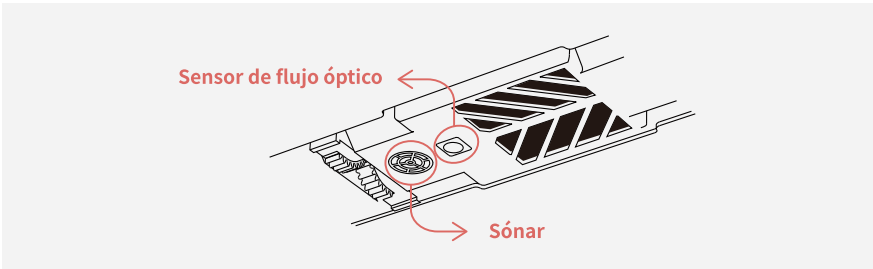
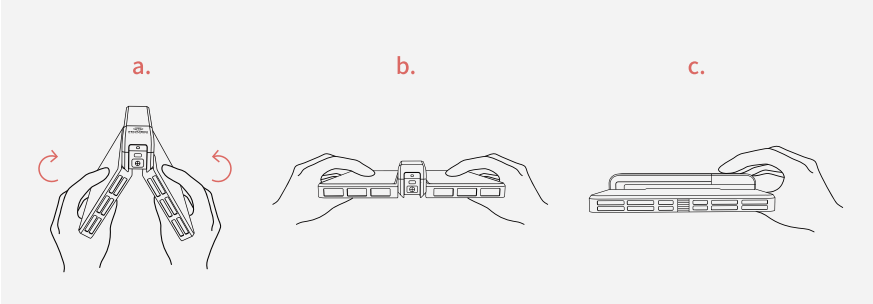

Precaución: No cubra el sensor de flujo óptico ni el sonda antes de soltar el Hover Camera Passport.

Cuando las hélices giren a mayor velocidad, suelte el Hover Camera Passport.

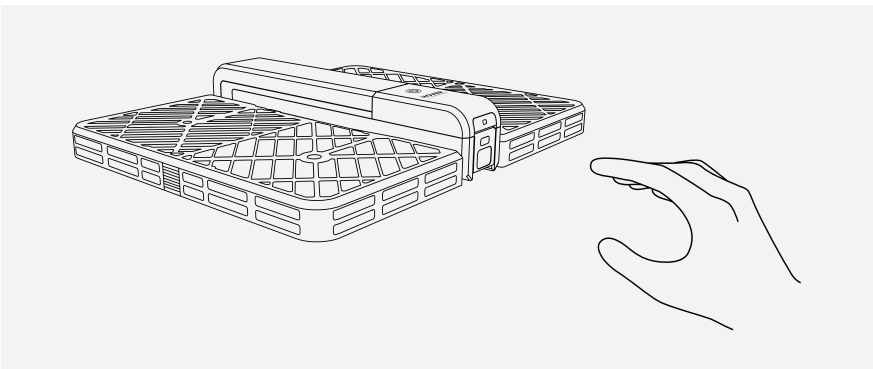

Paso 6: Controle el Hover Camera Passport

Abra la aplicación Hover Camera y disfrute volando el Hover Camera Passport.

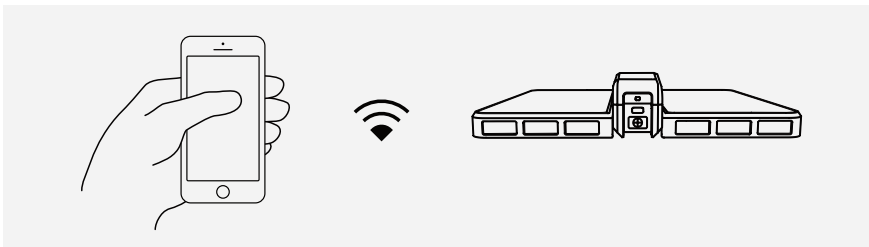

Paso 7: Recupere o aterrice el Hover Camera Passport

Sujete el Hover Camera Passport como se indica y, a continuación, pulse el botón de encendido para detener las hélices.

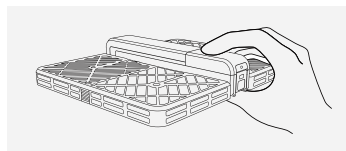

ES

También puede tocar el icono "Aterrizaje"



en la aplicación para que el Hover Camera Passport aterrice.

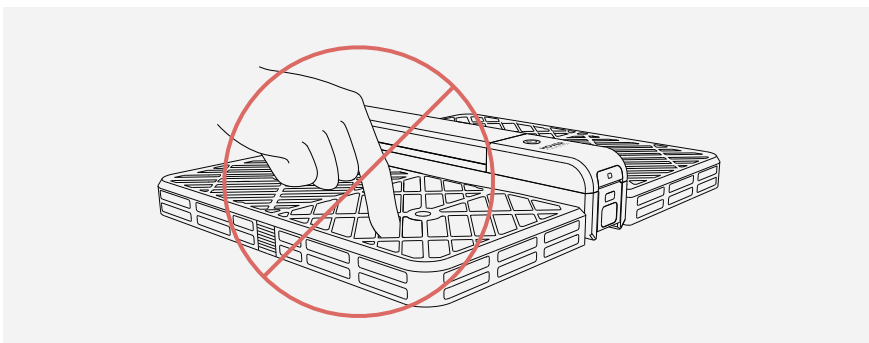

Precaución:

No inserte los dedos ni ningún objeto en el marco.

Para obtener más información, consulte el documento Descarga de responsabilidad e instrucciones de seguridad en GetHover.com/support.

Étape 1 : Télécharger l'application Hover Camera

Scannez le code QR ci-dessous afin de télécharger et d'installer l'application Hover Camera.



Pour de plus amples informations, téléchargez le manuel de l'utilisateur disponible sur le site Web officiel.

*Ce guide est susceptible d'être modifié sans préavis. Veuillez visiter le site officiel pour de plus amples informations.

Étape 2 : Charger la batterie

Pour charger les batteries, branchez-les sur le chargeur :

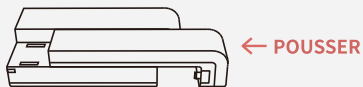

Remarque : le chargeur permet de charger jusqu'à deux batteries en même temps.

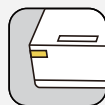

Jaune fixe : chargement



Vert fixe : complètement chargée

Remarque : une batterie complètement chargée offre une meilleure expérience de vol.

FR

Étape 3 : Brancher/ retirer la batterie

Appuyez en tenant fermement les prises de chaque côté de la batterie et tirez celle-ci fermement tel qu'illustré ci-dessous.

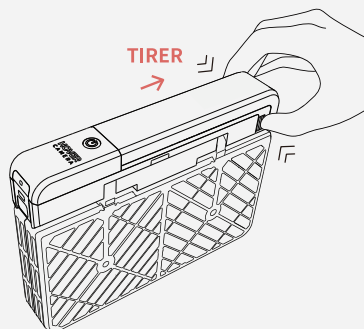
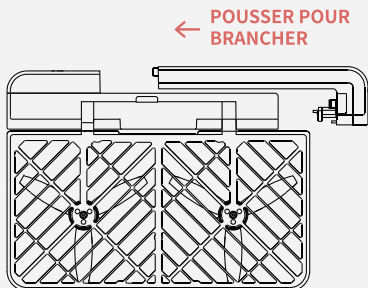

Étape 4 : Activer et connecter

Appuyez pendant 2 secondes sur le bouton de marche/arrêt jusqu'à ce que le voyant LED vert clignote deux fois. Attendez environ 15 secondes pendant l'initialisation du Hover Camera Passport. Une fois le démarrage terminé, vous entendrez un signal sonore. Au même moment, le voyant d'alimentation du Hover Camera Passport s'arrêtera de clignoter et affichera une couleur fixe.

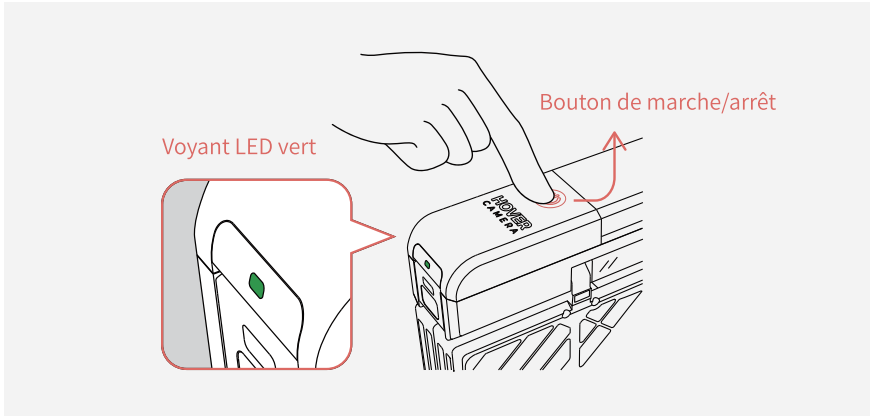

Accédez aux paramètres Wi-Fi de votre appareil et connectez-le au point d'accès Hover Camera.

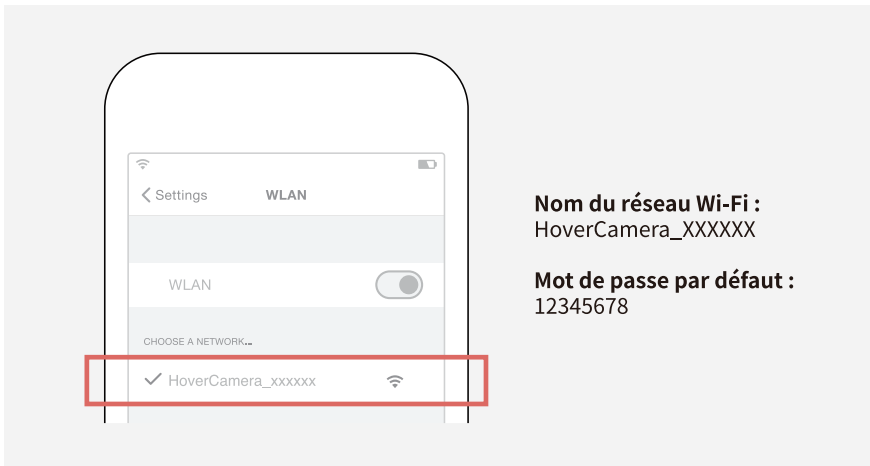

Nous vous recommandons de modifier le nom de votre réseau Wi-Fi et le mot de passe par défaut.

Étape 5 : Déballez et utilisez le Hover

Dépliez le Hover Camera Passport et tenez-le au niveau du sol. Appuyez sur le bouton d'alimentation pour démarrer les hélices.

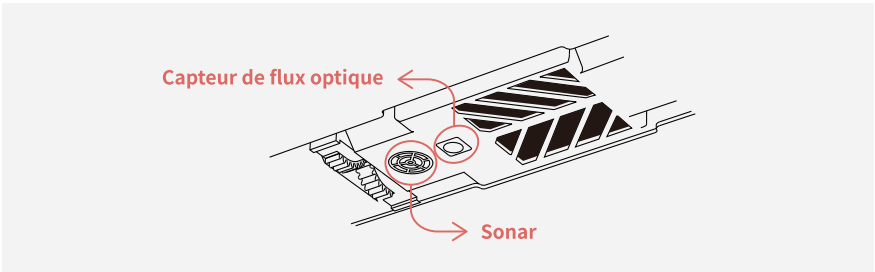
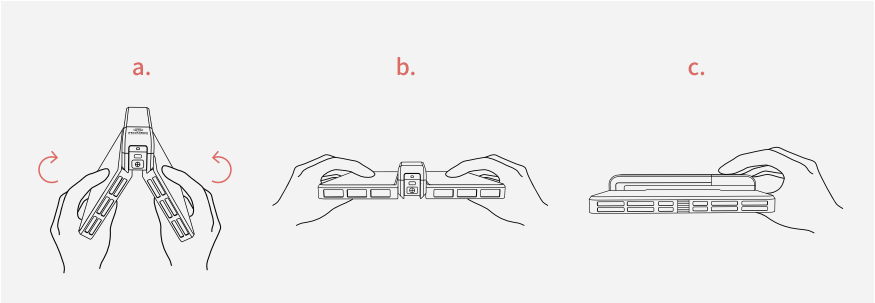

FR

Attention : ne pas couvrir le capteur de flux optique et le sonar avant de lâcher le Hover Camera Passport.

Lorsque les hélices commencent à tourner, c'est parti!

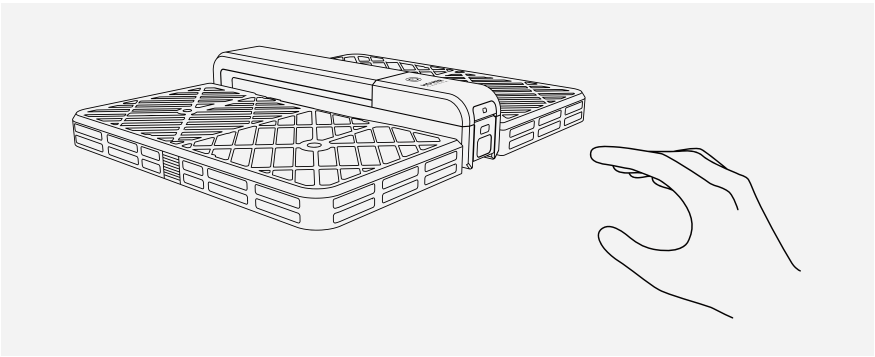

Étape 6 : Commander votre Hover Camera Passport

Ouvrez l'application Hover Camera et faites voler le Hover Camera Passport.

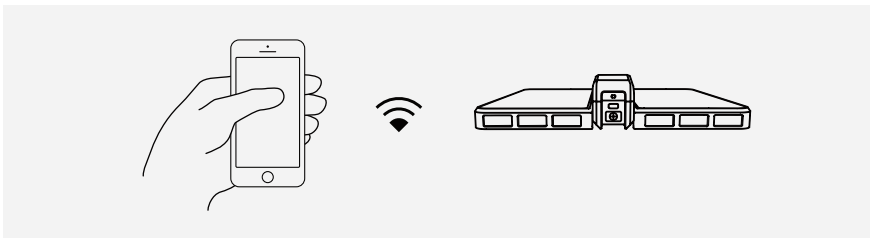

Étape 7 : Récupérer/ faire atterrir le Hover Camera Passport

Attrapez le Hover Camera Passport comme indiqué, et appuyez sur le bouton d'alimentation pour arrêter les hélices.

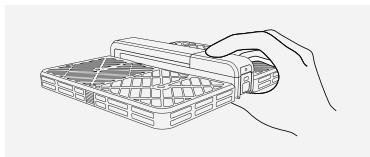

Ou appuyez sur l'icône Landing

dans l'application pour faire atterrir le Hover Camera Passport.

FR

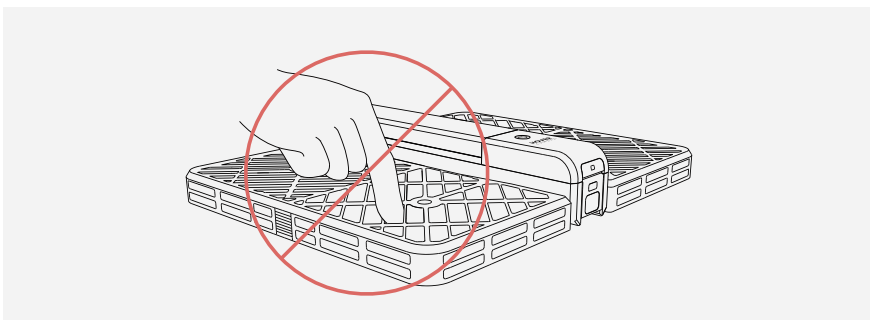

Attention :

ne pas insérer les doigts ou d'objets dans la structure.
Pour plus de détails, consulter la Clause de non-responsabilité et les Consignes de sécurité sur GetHover.com/support.

Passaggio 1: Download dell'app di Hover Camera

Scansionare il codice QR qui a lato per scaricare e installare l'app di Hover Camera.



Per maggiori informazioni, scaricare il Manuale dell'utente dal sito Web ufficiale.

*La presente guida è soggetta a modifiche senza preavviso. Per informazioni più dettagliate, visitare il sito Web ufficiale.

Passaggio 2: Ricarica della batteria

Per ricaricare la batteria, inserirla nell'apposito caricabatterie:

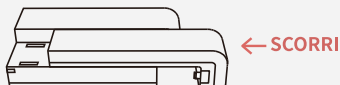

Nota: il caricabatterie può ricaricare fino a 2 batterie alla volta.

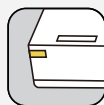

Giallo fisso: in carica



Verde fisso: completamente carica

Nota: una batteria completamente carica garantisce una migliore esperienza di volo.

Passaggio 3: Collegamento/Rimozione batteria

IT Premere a lungo le prese sui lati della batteria ed estrarla, come illustrato.

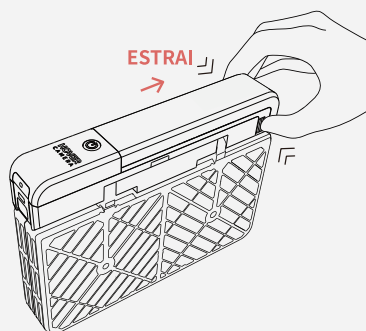
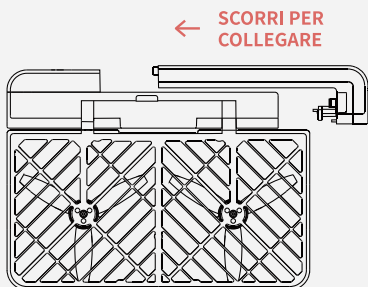

Passaggio 4: Attivazione e connessione

Premere il pulsante di alimentazione per 2 secondi fino a quando la spia verde dell'indicatore LED lampeggia per due volte. Attendere circa 15 secondi per l'inizializzazione di Hover Camera Passport. Una volta terminato l'avvio, viene emesso un segnale acustico. Allo stesso tempo, la spia dell'alimentazione di Hover Camera Passport smette di lampeggiare e si illumina di un colore fisso.

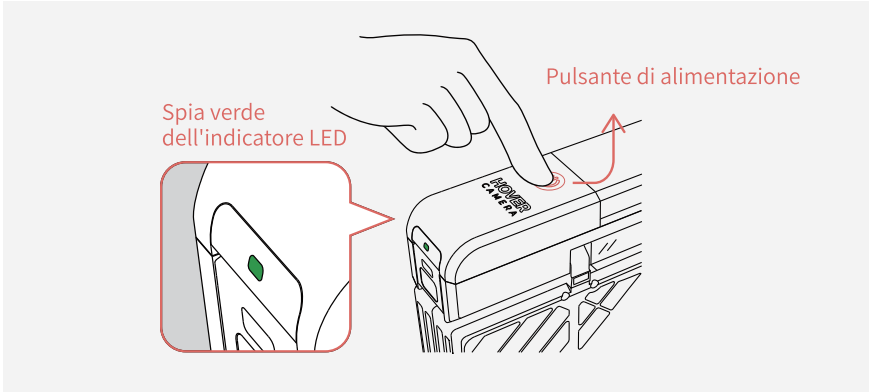

Accedere alla schermata delle impostazioni Wi-Fi sul dispositivo e collegare il dispositivo all'hotspot "Hover Camera".

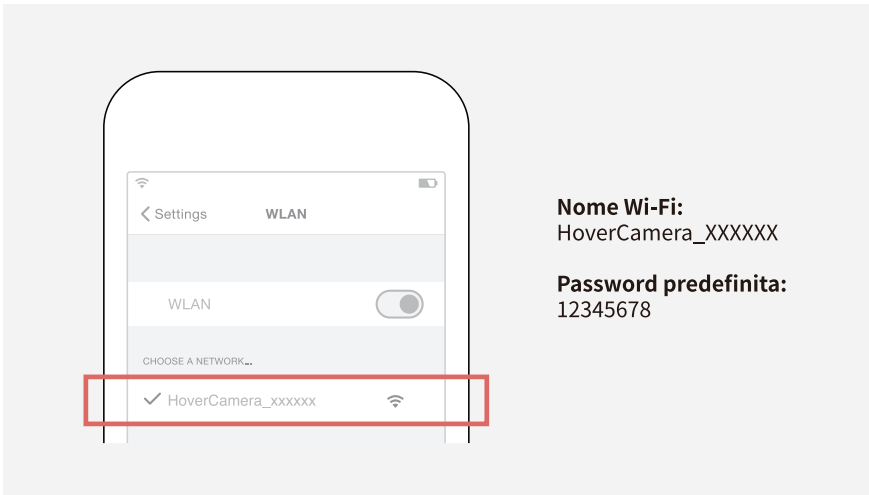

Consigliamo di modificare il nome della rete Wi-Fi e la password predefinita.

Passaggio 5: Rilascio e volo

Spiegare Hover Camera Passport e tenerlo al livello del suolo. Premere il pulsante di alimentazione per avviare le eliche.

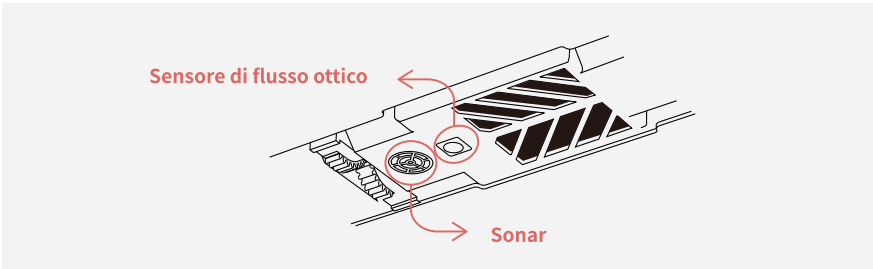
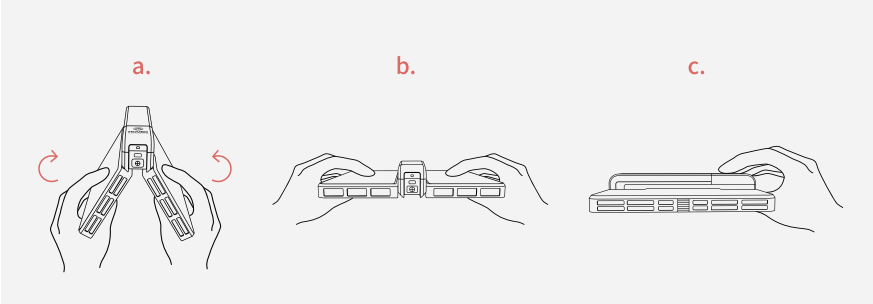

Attenzione: non coprire il sensore di flusso ottico o il sonar prima di rilasciare il dispositivo.

IT

Lasciarlo andare non appena le eliche accelerano.

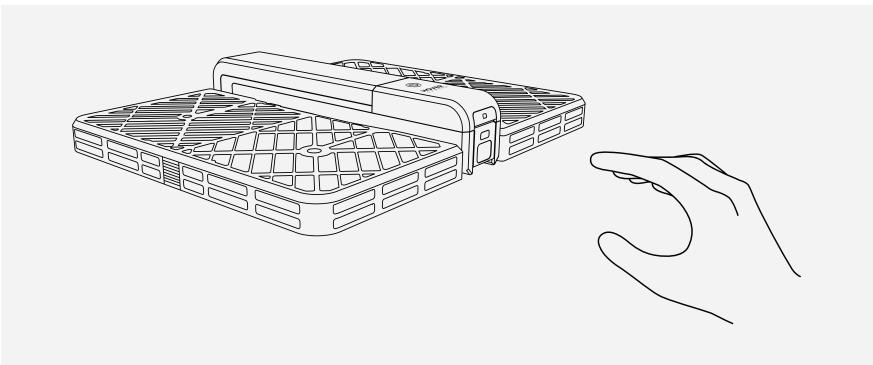

Passaggio 6: Controllo di Hover Camera Passport

Aprire l'app di Hover Camera e far volare Hover Camera Passport.

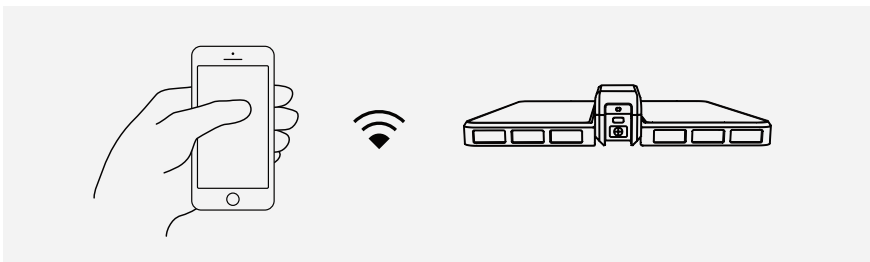

Passaggio 7: Recupero/Atterraggio di Hover Camera Passport

Afferrare Hover Camera Passport come illustrato, quindi premere il pulsante di alimentazione per arrestare le eliche.

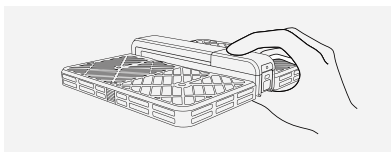

In alternativa, toccare l'icona "Atterraggio"



nell'app per far atterrare Hover Camera Passport.



Attenzione:

Non inserire dita o oggetti nel telaio.

Per maggiori dettagli, consultare la Dichiarazione di non responsabilità e le Istruzioni di sicurezza alla pagina GetHover.com/support.

Stap 1: Download de Hover Camera App

Scan de onderstaande QR-code om de Hover Camera App te downloaden en te installeren.



Download de gebruikershandleiding van de officiële website voor meer informatie.

*Deze handleiding is onderhevig aan verandering zonder voorafgaande kennisgeving. Ga naar de officiële website voor meer gedetailleerde informatie.

Stap 2: De accu opladen

Plaats de accu's in de oplader om ze op te laden:



Opmerking: De oplader kan maximaal 2 accu's tegelijk opladen.

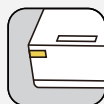

Ononderbroken geel:
Bezig met opladen



Ononderbroken groen:
Volledig opgeladen

Opmerking: Een volledig opgeladen accu biedt een beter vliegervaring.

Stap 3: Aansluiten / verwijderen van de accu

Druk de grepen in aan beide zijden van de accu en houd ze ingedrukt. Trek de accu er vervolgens krachtig uit zoals aangegeven.

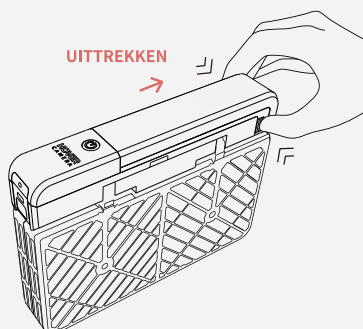
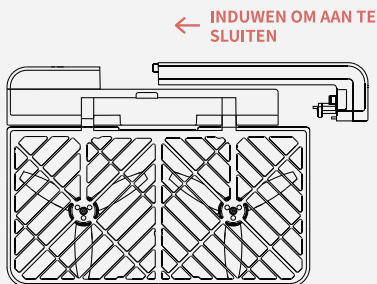

Stap 4: Inschakelen en verbinding maken

Houd de aan/uit-knop gedurende 2 seconden ingedrukt tot het groene ledlampje twee keer knippert. Wacht ongeveer 15 seconden op de initialisatie van de Hover Camera Passport. Zodra het klaar is met opstarten, zult u een geluid horen. Op hetzelfde moment zal het aan/uit-lampje van de Hover Camera Passport stoppen met knipperen en ononderbroken gaan branden.

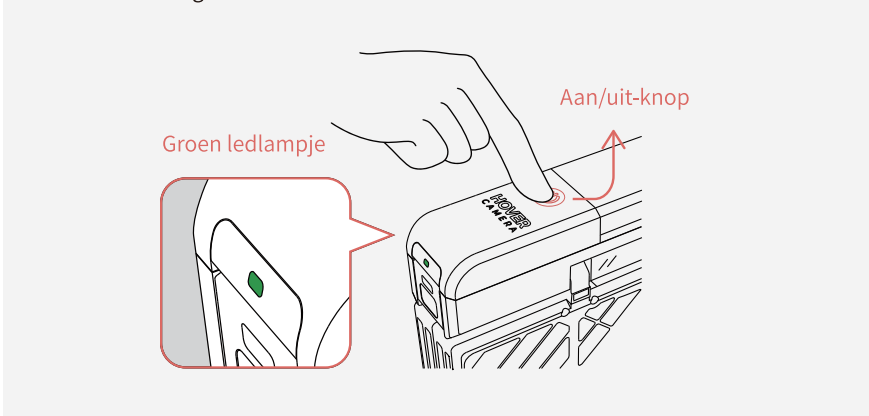

Open het Wi-Fi-instellingen-scherm op uw apparaat en laat het apparaat verbinden maken met de “Hover Camera”-hotspot.

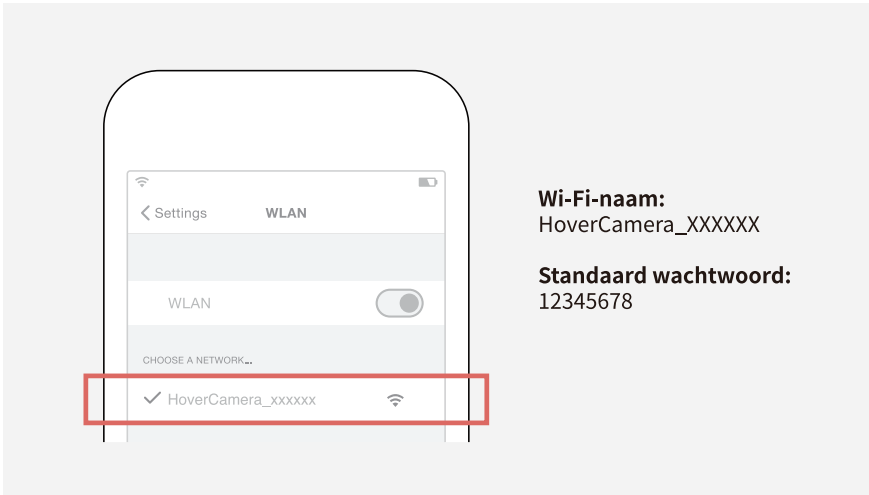

We raden u aan uw Wi-Fi-naam en standaard wachtwoord te wijzigen.

Stap 5: Loslaten en laten zweven

Ontvouw de Hover Camera Passport en houd het horizontaal boven de grond vast. Druk op de aan/uit-knop om de propellers te starten.

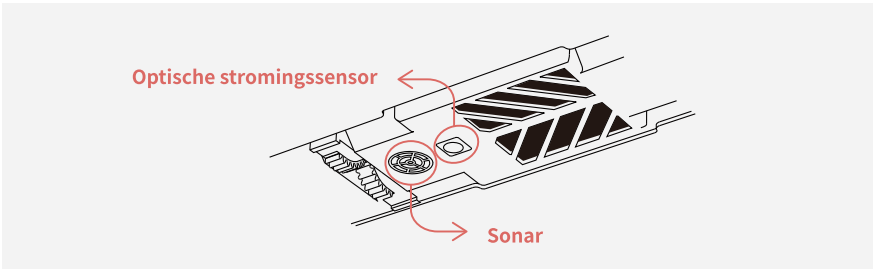
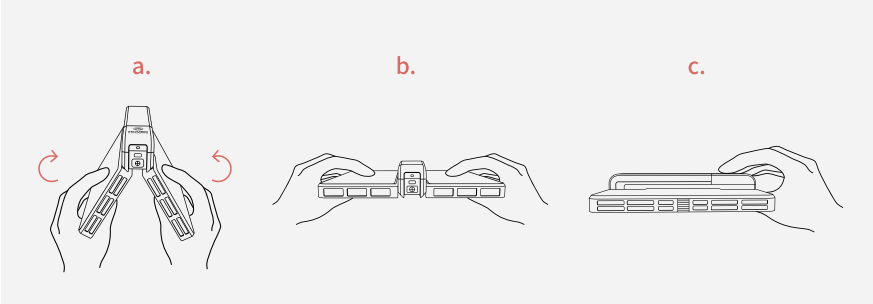

Voorzichtig : Bedek niet de optische stromingssensor of sonar alvorens het loslaten.

Wanneer de propellers versnellen, loslaten!

NL

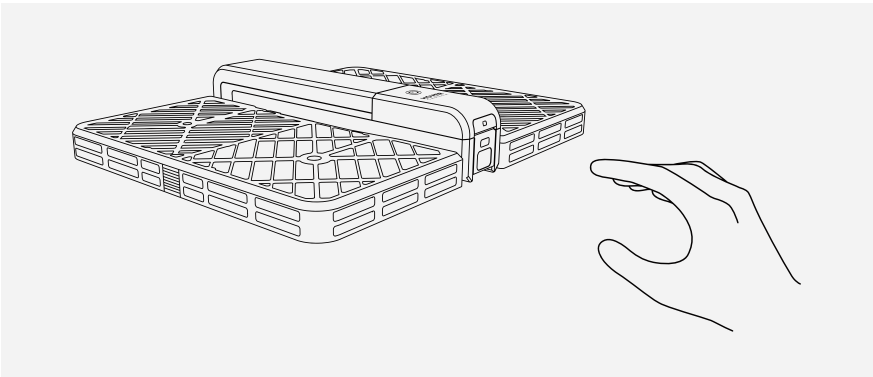

Stap 6: Uw Hover Camera Passport bedienen

Open de Hover Camera App en geniet van het vliegen met de Hover Camera Passport.

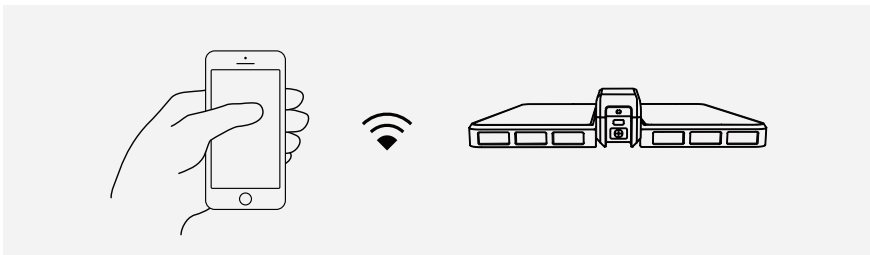

Stap 7: Ophalen/Landen van de Hover Camera Passport

Pak de Hover Camera Passport op zoals aangegeven en druk vervolgens op de aan/uit-knop om de propellers te stoppen.

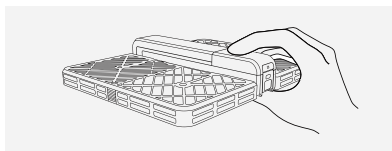

Of tik op het pictogram “Landing”



in de app om de Hover Camera Passport te landen.

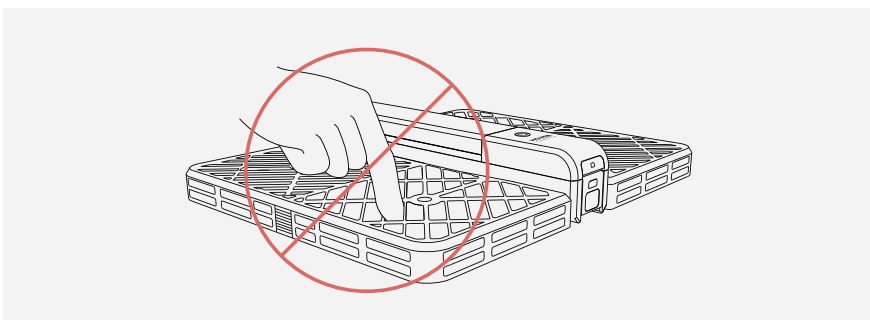

Voorzichtig:

Stop geen vinger of object in het frame.

Raadpleeg de vrijwaring en veiligheidsinstructies voor meer informatie op GetHover.com/support.

Passo 1: Transferir a aplicação Hover Camera

Leia o código QR abaixo para transferir e instalar a aplicação Hover Camera.



Para mais informações, transfira o Manual de utilizador a partir do site oficial.

*Este guia está sujeito a alterações sem aviso prévio. Aceda ao site oficial para informações mais detalhadas.

Passo 2: Carregar a bateria

Para carregar baterias, ligue-as ao carregador de bateria:



Nota: O carregador pode carregar até 2 baterias ao mesmo tempo.

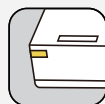

Amarelo sólido: A carregar



Verde sólido: Totalmente carregada

Nota: Uma bateria totalmente carregada oferece uma melhor experiência de voo.

Passo 3: Ligar / Remover a bateria

Pressione sem soltar os ganchos em cada um dos lados da bateria, e puxe a bateria firmemente, como demonstrado.

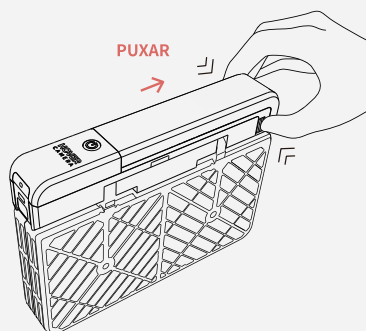
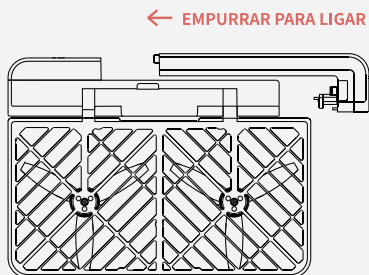

Passo 4: Ligar e Emparelhar

Prima o botão Ligar/Desligar durante 2 segundos até que a luz indicadora LED verde pisque duas vezes. Aguarde durante aproximadamente 15 segundos enquanto a Hover Camera Passport inicia. Assim que terminar o arranque, ouvirá um som. Ao mesmo tempo, a luz da Hover Camera Passport irá parar de piscar e tornar-se-á numa cor sólida.

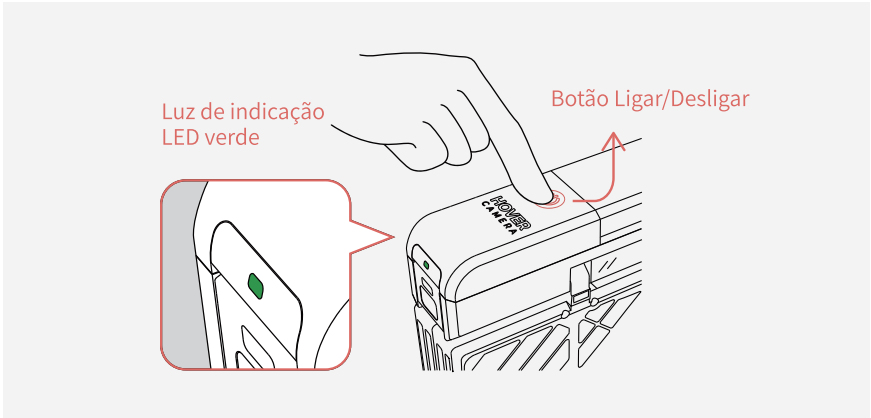

Aceda ao ecrã das definições do WiFi no seu dispositivo e ligue-o ao hotspot "Hover Camera".

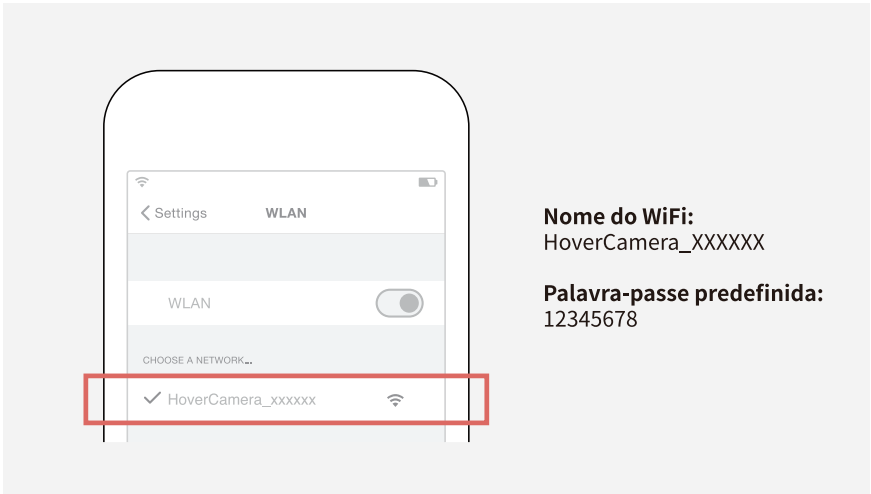

Recomendamos que mude o nome do seu WiFi e a palavra-passe predefinida.

Passo 5: Libertar e Pairar

Desdobre a Hover Camera Passport e segure-a ao nível do chão. Prima o botão Ligar/Desligar para ligar as hélices.

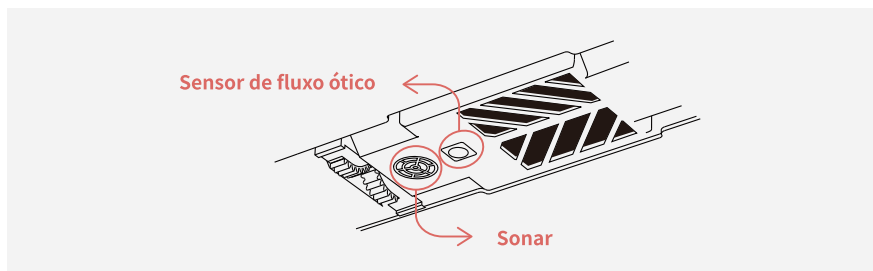
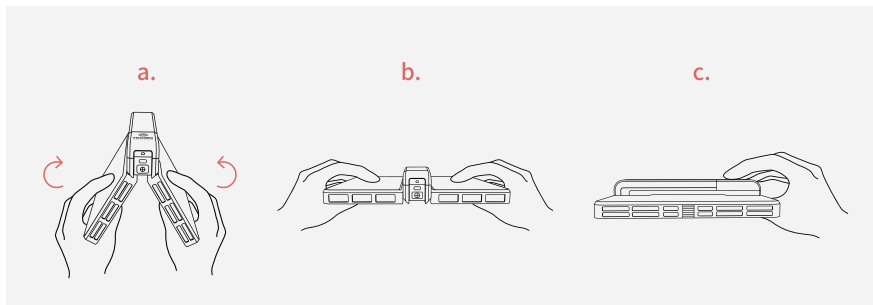

Atenção: Não cubra o sensor de fluxo ótico ou o sonar antes de libertar a Hover Camera Passport.

Quando as hélices acelerarem, liberte!

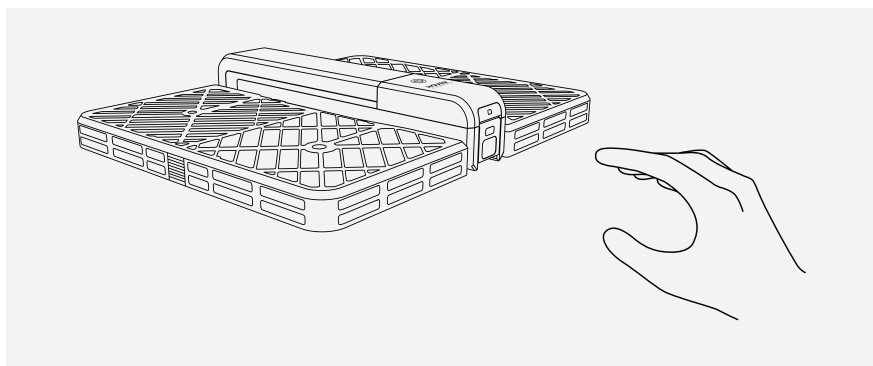

Passo 6: Controlar a Hover Camera Passport

Abra a aplicação Hover Camera e divirta-se a voar a Hover Camera Passport.

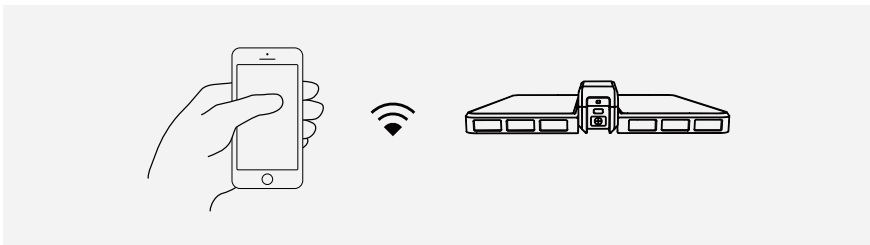

Passo 7: Recuperar/Aterrar a Hover Camera Passport

Segure na Hover Camera Passport como demonstrado, e, de seguida, prima o botão Ligar/Desligar para parar as hélices.

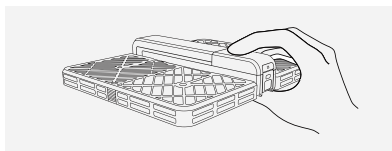

Ou toque no ícone "Aterrar"  na aplicação para aterrar a Hover Camera Passport.



Atenção:

Não insira os dedos ou objetos na estrutura.

Para mais detalhes, consulte a Isenção de responsabilidade e Instruções de segurança em GetHover.com/support.

Шаг 1: Загрузите приложение Hover Camera

Отсканируйте приведенный ниже QR-код, чтобы загрузить и установить приложение Hover Camera.



Для получения дополнительной информации загрузите руководство по эксплуатации с официального веб-сайта.

* Это руководство может быть изменено без предварительного уведомления. См. подробную информацию на официальном веб-сайте.

Шаг 2: Зарядите аккумулятор

Чтобы зарядить аккумуляторы, вставьте их в зарядное устройство:



← НАЖАТЬ

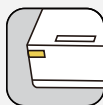

Постоянно горит желтым цветом: идет зарядка



Постоянно горит зеленым цветом: полный заряд

Примечание.

В зарядном устройстве можно одновременно заряжать до 2 аккумуляторов.

Примечание.

При полностью заряженным аккумуляторе квадрокоптер можно использовать более эффективно.

Шаг 3: Установка/извлечение аккумулятора

Нажмите и удерживайте точки захвата с обеих сторон аккумулятора, затем вытяните аккумулятор, как показано на рисунке.

← НАЖАТЬ ДЛЯ ПОДКЛЮЧЕНИЯ

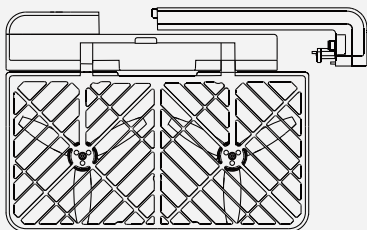

ПОТЯНУТЬ →

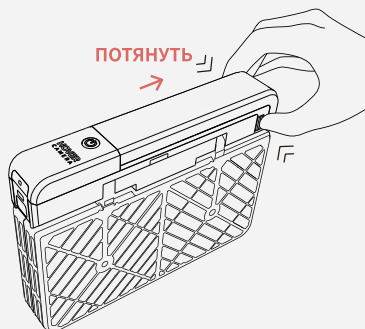

Шаг 4: Включение и установка соединения

Нажмите кнопку питания на 2 секунды, пока зеленый светодиодный индикатор не мигнет дважды. Подождите примерно 15 секунд, пока идет инициализация Hover Camera Passport. По окончании загрузки раздастся звуковой сигнал.

Одновременно индикатор питания Hover Camera Passport перестанет мигать и загорится постоянно.

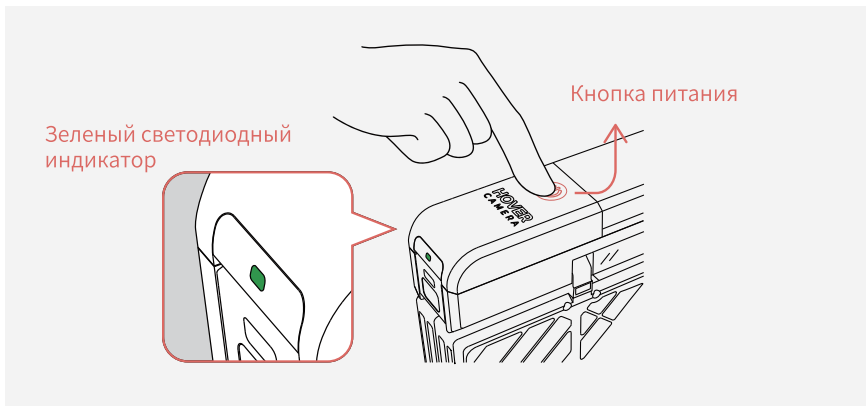

Откройте окно настроек Wi-Fi на вашем устройстве и подключите устройство к беспроводной точке доступа «Hover Camera».

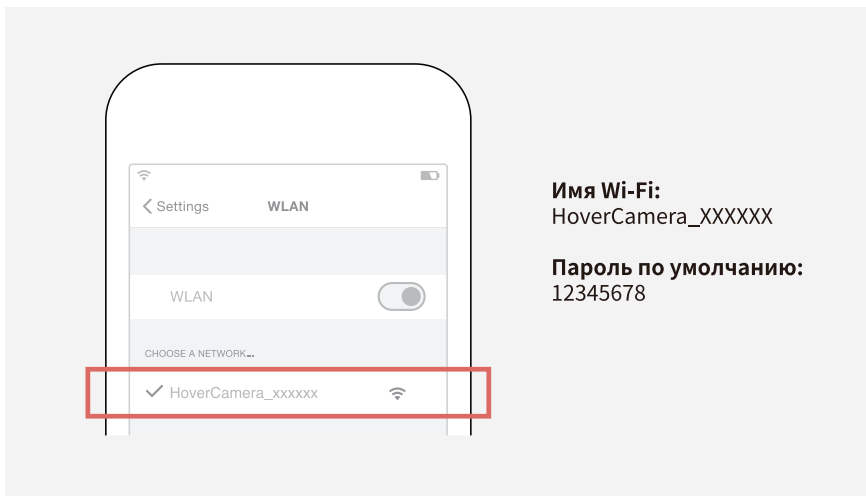

Рекомендуется изменить имя и пароль Wi-Fi, предоставленные по умолчанию.

Шаг 5: Запуск и парение

Раскройте Hover Camera Passport и разместите его параллельно земле. Нажмите кнопку пуска, чтобы включить пропеллеры.

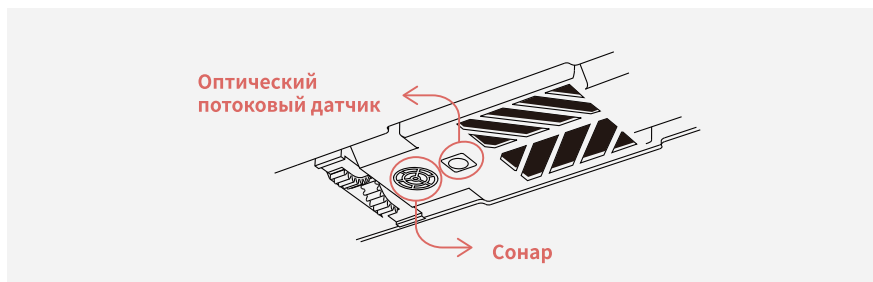
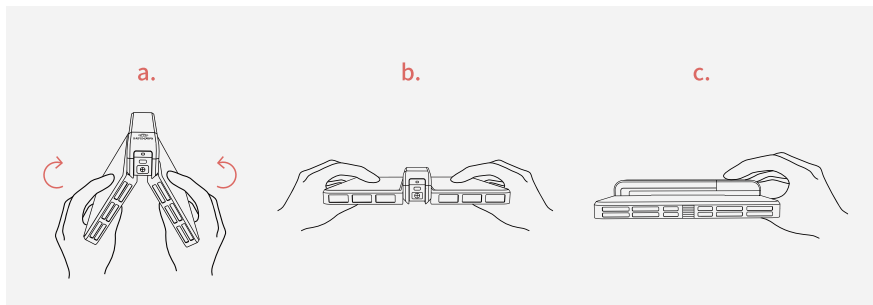

Внимание: Не закрывайте оптический потоковый датчик или сонар перед тем, как запустить устройство.

Когда пропеллеры наберут скорость, отпустите устройство!

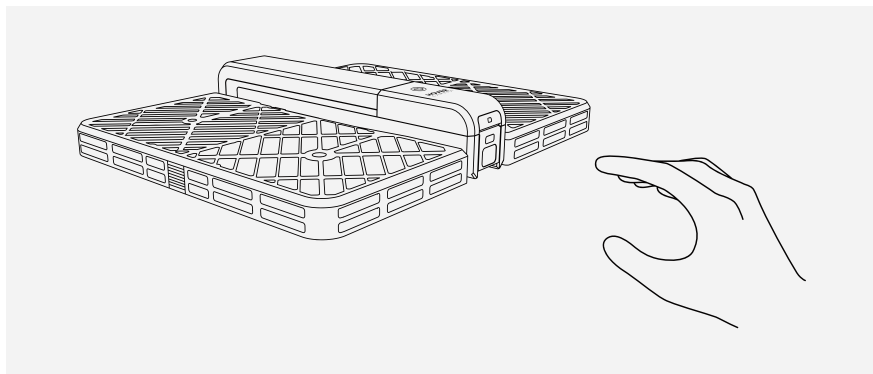

Шаг 6: Управление Hover Camera Passport

Откройте приложение Hover Camera и приступайте к управлению Hover Camera Passport.

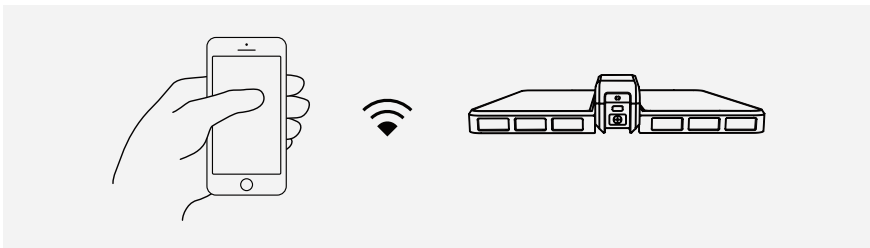

Шаг 7: Верните/приземлите Hover Camera Passport

Возьмите Hover Camera Passport, как показано на рисунке, затем нажмите кнопку питания, чтобы выключить пропеллеры.

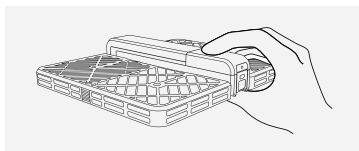

Или коснитесь значка «Приземление»



в приложении, чтобы посадить квадрокоптер Hover Camera Passport.

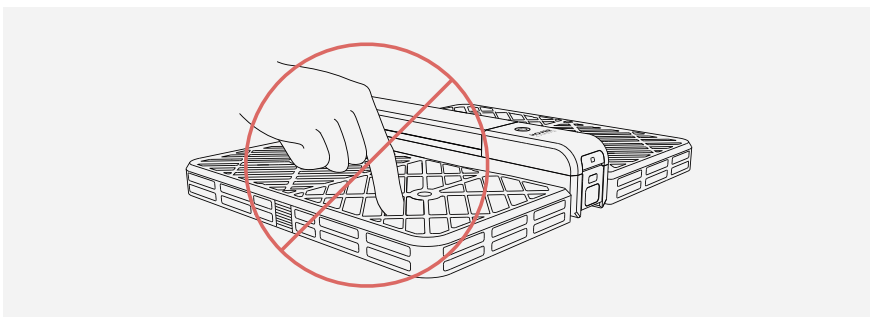

Внимание: Не вставляйте пальцы или какие-либо предметы в раму. Для получения более подробной информации ознакомьтесь с отказом от ответственности и правилами техники безопасности по адресу GetHover.com/support.

GetHover.com

Copyright © 2016 Shenzhen Zero Zero Infinity Technology Co., Ltd.
All Rights Reserved.