



zzrobotics.com

Quick Start Guide

快速入门指南

ZEROZERO
ROBOTICS

© 2022 ZeroZeroTech - All Rights Reserved
深圳零零无限科技有限公司 版权所有

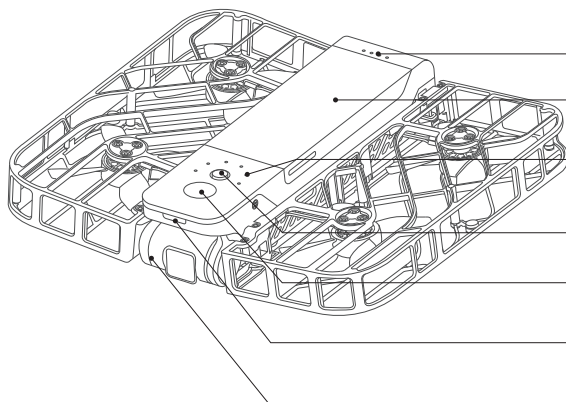

Battery Level Indicator

电池电量指示灯

Battery

电池

Mode Indicator

模式指示灯

Mode Button

模式切换按键

Power & Takeoff button

开关/放飞按键

Status Indicator

状态指示灯

Gimbal Camera

云台

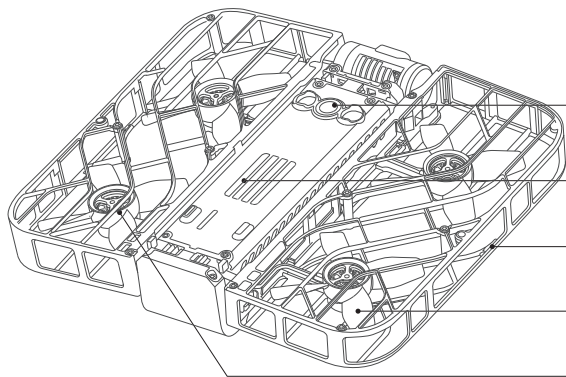

Downward Vision System

底部视觉传感器

Heat Vents

散热口

Prop Guards

边框

Propeller

螺旋桨

Motor

电机

Step 1 Download App

- Scan the QR code below to download and install Hover X1 App.

*This guide is subject to changes without prior notice. Please visit our official website for user manual and other latest info.



Step 2 Charge the battery

- When you are using Hover Camera X1 for the first time, be sure to charge it.

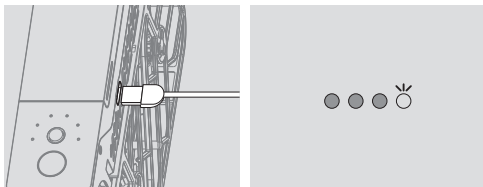

Connect the USB cable and USB power source.
When battery is being charged, LEDs will breath.

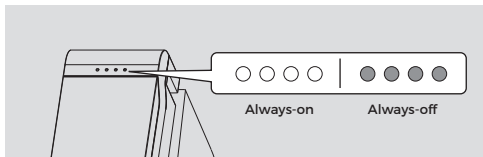

When battery is fully charged, LEDs will turn always-on then always-off

Step 3 Power on

- Press and hold power button for 2 seconds, Hover Camera X1 will power on. The status LED will light on.

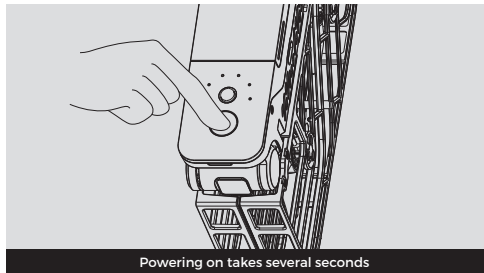

Step 4 Release and fly

- Spread Hover Camera X1 as shown below. You can switch modes using mode button. Hold Hover Camera X1 horizontally. Short press power button.

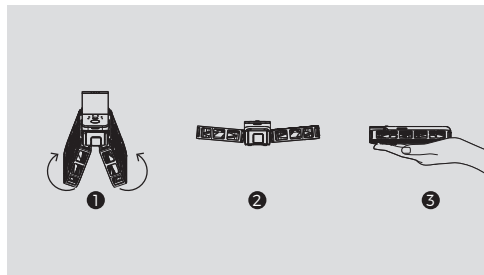

- All props will start spinning . Release Hover Camera X1 and it will perform the flight.

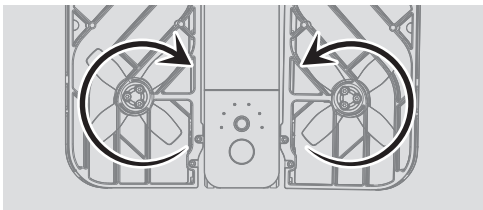

- Take off

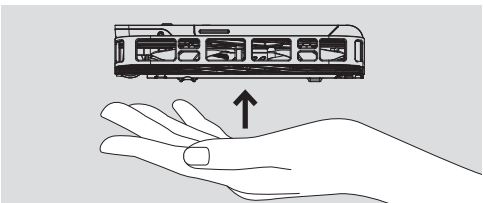

Step 5 Collect Hover Camera X1

- Press power button or flip Hover Camera X1 during flight will stop flight task.

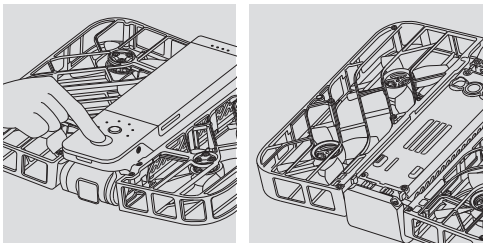

propellers will stop spinning

- Put your hand 20 cm below Hover Camera X1, Hover Camera X1 will automatically land on your hand and stop spinning.

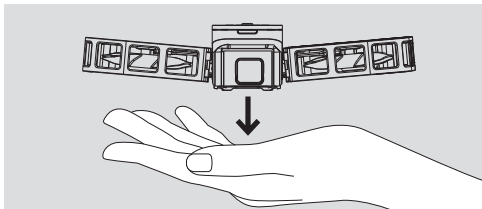

- Caution

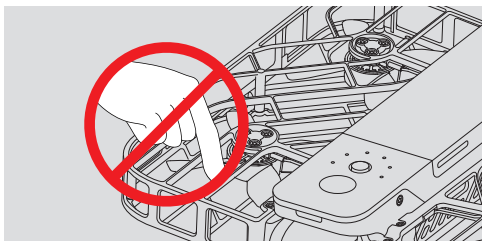

DO NOT stick in finger or anything else into propeller area.
Please refer to the safety instruction book and disclaimer on zzrobotics.com/support for more info

Step 6 App connection

- Open the Hover X1 App and enjoy flying Hover Camera X1,

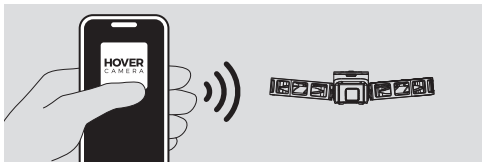

第一步 下载 App

- 扫描二维码下载并安装Hover X1 App
了解更多信息，请前往官网下载《用户手册》。
*本指南如有更新，恕不另行通知。请登录官网获取最新信息。



第二步 充电

- 给电池充电

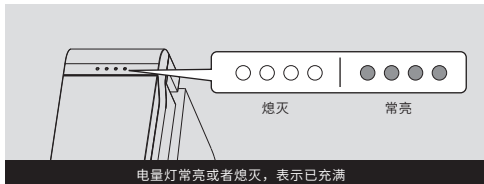
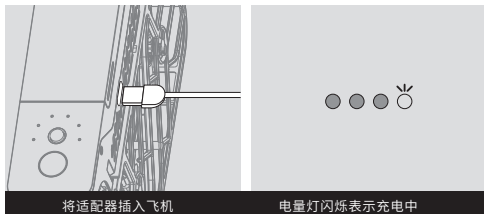

第三步 开关机

- 长按电源键约2秒至开机语音响起，状态灯点亮绿色。

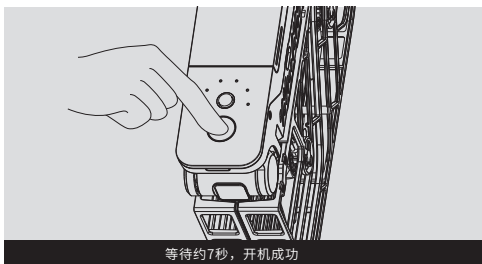

第四步 模式选择、放飞

- 如下图所示展开Hover Camera X1并端平
短按模式按键进行模式选择，然后短按电源键。

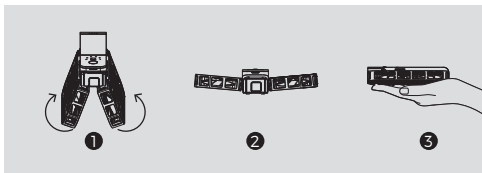

- 当螺旋桨快速旋转时即可松手放飞

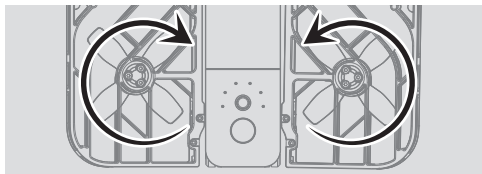

■ 起飞

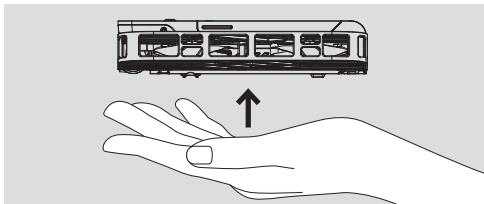

第五步 收回/降落Hover Camera X1

- 摘取飞行中的Hover Camera X1并短按电源键,或者旋转飞机180度,螺旋桨将停止旋转。

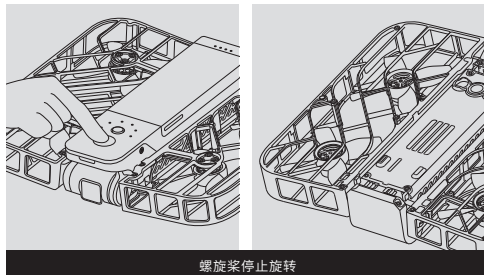

- 将手置于无人机正下方20cm左右,无人机自动降落到手掌并螺旋桨停止旋转

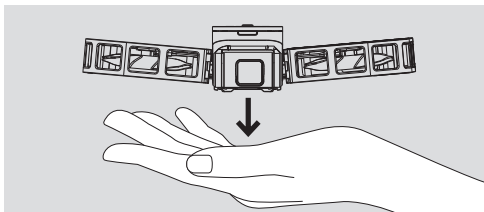

■ 注意

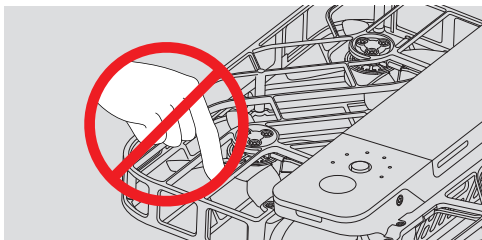

请勿将手指或其他物品伸入手指保护内。更多安全事项请参考 zzrobotics.com/support 上的免责声明和安全操作手册。

第六步 连接App

- 打开Hover X1 App, 享受飞行操控带来的极致体验。

